

Clamps

Service pressure ratings are based on the following parameters: matching elastomer gaskets and weld ferrules properly aligned and assembled with the clamps tightened to the required torque (25 in. lbs.). Tests are done hydrostatically with no water hammer or shock loads. Please note the pressure ratings of the described unions are above the recommended pipe line operating pressures.

"A Tale of Two Clamps" YouTube Link
<http://youtu.be/LEwAjHaW5II>



Single Pin Squeeze Clamps - 13MHHM-Q

- patented design



Tube OD	Dimension A	304 Stainless Steel	
		Part #	Price/E
1/2" - 3/4"	1.062	13MHHM-Q75	\$33.80
1" - 1 1/2"	2.122	13MHHM-Q100150	41.55
2"	2.654	13MHHM-Q200	48.65
2 1/2"	3.185	13MHHM-Q250	62.80
3"	3.717	13MHHM-Q300	65.85
4"	4.820	13MHHM-Q400	76.50

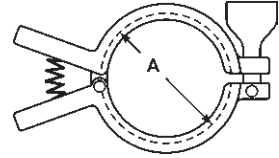

Single Pin Heavy Duty Clamps - 13MHHM with cross hole wing nut



Tube OD	Dimension A	304 Stainless Steel	
		Part #	Price/E
1/2" - 3/4"	1.062	13MHHM50-75	\$9.20
1" - 1 1/2"	2.122	13MHHM100-150	17.35
2"	2.654	13MHHM200	18.75
2 1/2"	3.185	13MHHM250	21.45
3"	3.717	13MHHM300	23.45
4"	4.820	13MHHM400	29.55
5"	5.820	13MHHM500	84.10
6"	6.695	13MHHM600	63.25
8"	8.695	13MHHM800	90.75

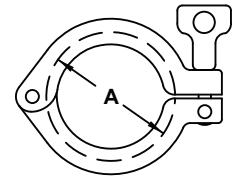

Single Pin Heavy Duty Clamps - 13MHHM***SN with serrated wing nut



Tube OD	Dimension A	304 Stainless Steel	
		Part #	Price/E
1/2" - 3/4"	1.062	13MHHM50-75SN	\$9.20
1" - 1 1/2"	2.122	13MHHM100-150SN	17.35
2"	2.654	13MHHM200SN	18.75
2 1/2"	3.185	13MHHM250SN	21.45
3"	3.717	13MHHM300SN	23.45
4"	4.820	13MHHM400SN	29.55
6"	6.695	13MHHM600SN	63.25
8"	8.695	13MHHM800SN	90.75

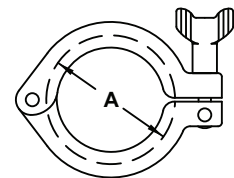

Double Pin Heavy Duty Clamps - 13MHHM-DP



Tube OD	Dimension A	304 Stainless Steel	
		Part #	Price/E
1" - 1 1/2"	2.122	13MHHM-DP100150	\$21.60
2"	2.654	13MHHM-DP200	24.55
2 1/2"	3.185	13MHHM-DP250	28.40
3"	3.717	13MHHM-DP300	31.95
4"	4.820	13MHHM-DP400	39.05
10"	10.740	13MHHM-DP1000	262.80

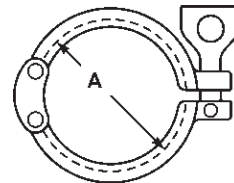

Clamps

3 Segment Clamps - 13MHMM-3P

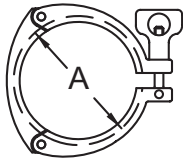

Tube OD	Dimension A	304 Stainless Steel	
		Part #	Price/E
1" - 1½"	2.122	13MHMM-3P100150	\$28.45
2"	2.654	13MHMM-3P200	32.65
2½"	3.185	13MHMM-3P250	39.20
3"	3.717	13MHMM-3P300	46.55
4"	4.820	13MHMM-3P400	55.60
12"	12.740	13MHMM-3P1200	632.45



- wing nut should be tightened to 25 in. lb. torque

Bolted Clamps - 13MHP

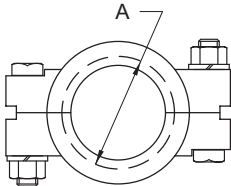
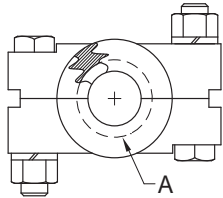

Tube OD	Dimension A	304 Stainless Steel	
		Part #	Price/E
½" - ¾"	1.062	13MHP75	\$28.45
1" - 1½"	2.046	13MHP100-150	34.05
2"	2.578	13MHP200	42.40
2½"	3.110	13MHP250	46.30
3"	3.640	13MHP300	56.35
4"	4.744	13MHP400	63.65
6"	6.632	13MHP600	94.50
8"	8.638	13MHP800	297.10
10"	10.740	13MHP1000	819.55
12"	12.740	13MHP1200	924.20



- nuts should be tightened to 20 ft. lbs. torque

Toggle Clamps - 13MHLA

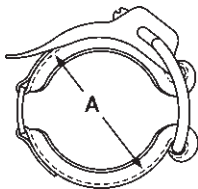

Tube OD	Dimension A	304 Stainless Steel	
		Part #	Price/E
1" - 1½"	2.122	13MHLA100-150	\$56.90
2"	2.654	13MHLA200	59.65
2½"	3.185	13MHLA250	64.10
3"	3.717	13MHLA300	101.90
4"	4.820	13MHLA400	108.30



Sanitary Fittings

T-bolt Clamps - 13MO

- 1" - 3" nuts tightened to 20 in. lb. of torque
- 4" nut tightened to 30 in. lb. of torque
- 6" nut tightened to 40 in. lb. of torque
- 8" - 12" nuts tightened to 50 in. lb. of torque
- all nuts are brass

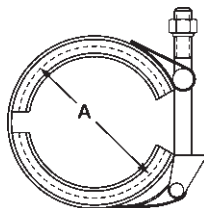

Tube OD	Dimension A	304 Stainless Steel	
		Part #	Price/E
1" - 1½"	2.080	13MO100-150	\$37.05
2"	2.610	13MO200	40.75
2½"	3.140	13MO250	49.95
3"	3.670	13MO300	50.90
4"	4.780	13MO400	71.50
6"	6.690	13MO600	98.95
8" *	8.690	13MO800	147.55
10" *	10.690	13MO1000	186.50
12" *	12.690	13MO1200	248.15



- * 2 bolt configuration

Clamps

Dairy Clamps - 13WGC

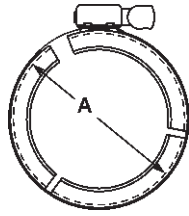

Tube OD	Service Pressure Rating @ 70°F *	Service Pressure Rating @ 250°F *	A	304 Stainless Steel	
				Part #	Price/E
1" - 1½"	100	75	2.080	13WGC100-150	\$13.25
2"	100	75	2.610	13WGC200	13.85
2½"	100	75	3.140	13WGC250	17.00
3"	100	75	3.670	13WGC300	18.35
4"	100	75	4.780	13WGC400	21.75

* finger tight

Accessories

Spring Loaded Nut - 13SLN

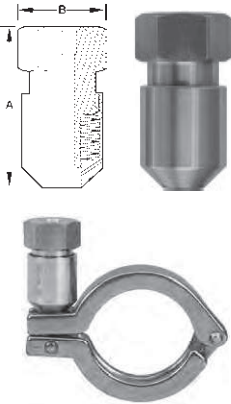

- Lines using PTFE gaskets that are subject to large temperature swings can benefit from this special product. As the PTFE is compressed through the cycling of the lines, the spring load will help keep the connection from leaking.
- If the lines suffer from vibration and bolted clamps are not an option, refitting single pin clamps with this nut will keep the connections from leaking for a longer time than the standard wing nuts.
- If you transport material in tanks via truck, the vibrations can loosen the standard single pin clamps. Spring loaded nuts can add a level of insurance to the shipment.
- *Note:* can be used on all wing nut style clamps

Thread	A	B	304 Stainless Steel	
			Part #	Price/E
5/16 - 18	1.73	.875	13SLN	\$99.40

* torque to 50 in. lb.

Torque-Rite® Nuts - 13TR



- an audible "click" indicating correct inch/pounds force
- maintains constant 30 or 50 inch/pounds force
- manual override feature
- retrofits all sanitary clamps, ¾" through 12"
- works in rupture disk applications
- no torque wrench or special training required

Description	Part #	Price/E
Torque-Rite® 30 in. lb nut	13TR-30	\$309.25
Torque-Rite® 50 in. lb nut	13TR-50	309.25

Nuts and Bolts



Description	Part #	Price/E
Cross hole wing nut 5/16"-18	13WNX	\$12.10
Mini cross hole wing nut 5/16"-18 for ½" - ¾" clamps	13WNXM	12.10
Serrated wing nut 5/16"-18	13WNS	12.10
Hex wing nut 5/16"-18	13WNH	12.10
Bronze hex nut 3/8"-16 for bolted clamps	13BN	2.85
Bolt 3/8"-16 x 2¼" for 1½" bolted clamps	13CB-2.25	9.25
Bolt 3/8"-16 x 2¾" for 2" and 2½" bolted clamps	13CB-2.75	9.25
Bolt 3/8"-16 x 3¼" for 3" - 12" bolted clamps	13CB-3.25	9.25
Rivet pin for ½" - 5" single pin clamps 5/16" x 1"	13RP	4.55
Rivet pin for 6" and 8" single pin clamps 5/16" x 1-1/8"	13RP6	5.60
5/16"-18 x 2" threaded eye bolt for ½" - 5" clamps	13IB	3.75
5/16"-18 x 2½" threaded eye bolt for 6" - 12" clamps	13IB6	3.75

Clamp Ferrules

Short Weld Ferrules - 14WMP 3

Tube OD	Dimensions			304 Stainless Steel		316L Stainless Steel	
	A	B	C	Part #	Price/E	Part #	Price/E
½"	.500	.370	.500	14WMP-G50	\$7.30	14WMP-R50	\$10.00
¾"	.500	.620	.750	14WMP-G75	7.30	14WMP-R75	10.00
1"	.500	.870	1.000	14WMP-G100	7.50	14WMP-R100	10.10
1½"	.500	1.370	1.500	14WMP-G150	7.50	14WMP-R150	10.10
2"	.500	1.870	2.000	14WMP-G200	9.00	14WMP-R200	12.25
2½"	.500	2.370	2.500	14WMP-G250	12.95	14WMP-R250	19.60
3"	.500	2.870	3.000	14WMP-G300	17.05	14WMP-R300	23.65
4"	.625	3.834	4.000	14WMP-G400	27.05	14WMP-R400	35.20
5"	.750	4.782	5.000	14WMP-G500	346.60	14WMP-R500	425.20
6"	.875	5.782	6.000	14WMP-G600	119.25	14WMP-R600	151.05
8"	.875	7.782	8.000	14WMP-G800	157.10	14WMP-R800	228.85
10"	.875	9.782	10.000	14WMP-G1000	370.35	14WMP-R1000	470.70
12"	.875	11.760	12.000	14WMP-G1200	575.60	14WMP-R1200	782.55

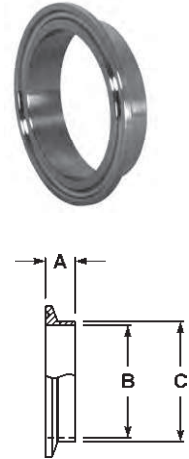

Long Weld Ferrules - L14AM7 3

Tube OD	Dimensions			304 Stainless Steel		316L Stainless Steel	
	A	B	C	Part #	Price/E	Part #	Price/E
½"	1.125	.370	.500	L14AM7-G50	\$9.70	L14AM7-R50	\$12.45
¾"	1.125	.620	.750	L14AM7-G75	9.70	L14AM7-R75	12.45
1"	1.125	.870	1.000	L14AM7-G100	11.40	L14AM7-R100	15.00
1½"	1.125	1.370	1.500	L14AM7-G150	11.40	L14AM7-R150	15.00
2"	1.125	1.870	2.000	L14AM7-G200	14.40	L14AM7-R200	18.65
2½"	1.125	2.370	2.500	L14AM7-G250	18.30	L14AM7-R250	28.15
3"	1.125	2.870	3.000	L14AM7-G300	23.95	L14AM7-R300	33.85
4"	1.125	3.834	4.000	L14AM7-G400	34.00	L14AM7-R400	45.50
6"	1.500	5.782	6.000	L14AM7-G600	222.40	L14AM7-R600	287.70
8"	1.500	7.782	8.000	L14AM7-G800	296.65	L14AM7-R800	498.95
10"	1.750	9.782	10.000	L14AM7-G1000	626.55	L14AM7-R1000	816.25
12"	1.750	11.760	12.000	L14AM7-G1200	957.60	L14AM7-R1200	1169.50

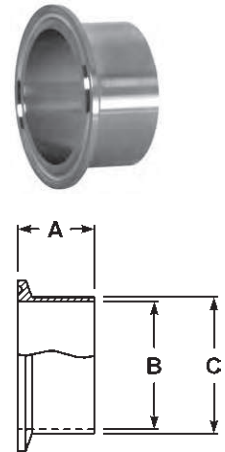

Sanitary Fittings

Automatic Weld Ferrules - TL14AM7 3

• meets ASME BPE-2009 specifications

Tube OD	Dimensions			316L Stainless Steel	
	A	B	C	Part #	Price/E
½"	1.750	.370	.500	TL14AM7-050PL	\$29.55
¾"	1.750	.620	.750	TL14AM7-075PL	29.55
1"	1.750	.870	1.000	TL14AM7-100PL	27.90
1½"	1.750	1.370	1.500	TL14AM7-150PL	27.90
2"	2.250	1.870	2.000	TL14AM7-200PL	32.25
3"	2.250	2.870	3.000	TL14AM7-300PL	67.55
4"	2.250	3.834	4.000	TL14AM7-400PL	151.40

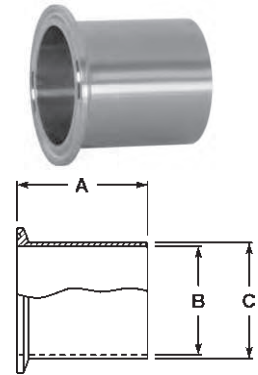

Tank Weld Ferrules (light duty) - 14WLMP 3

Tube OD	Dimensions				304 Stainless Steel		316L Stainless Steel	
	A	B	C	D	Part #	Price/E	Part #	Price/E
1"	3.000	.870	1.000	1.984	14WLMP-G100	\$31.25	14WLMP-R100	\$94.75
1½"	3.000	1.370	1.500	1.984	14WLMP-G150	31.25	14WLMP-R150	94.75
2"	3.000	1.870	2.000	2.516	14WLMP-G200	39.70	14WLMP-R200	122.20
2½"	3.000	2.370	2.500	3.047	14WLMP-G250	54.70	14WLMP-R250	173.60
3"	4.000	2.870	3.000	3.579	14WLMP-G300	68.45	14WLMP-R300	230.80
4"	4.000	3.834	4.000	4.682	14WLMP-G400	103.70	14WLMP-R400	346.45
6"	6.000	5.782	6.000	6.562	14WLMP-G600	508.70	14WLMP-R600	701.30

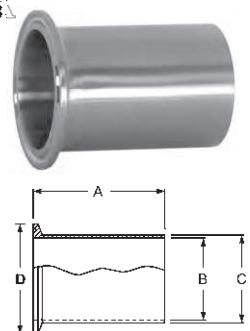

Clamp Ferrules

3 Tank Weld Ferrules (heavy wall) - 14MPW

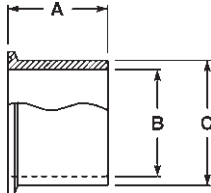

- certified ASME materials

Tube OD	Dimensions			316L Stainless Steel	
	A	B	C	Part #	Price/E
½"	1.625	.321	.502	14MPW-R50	\$74.60
¾"	1.625	.574	.750	14MPW-R75	74.60
1"	1.625	.870	1.160	14MPW-R100	38.30
1½"	1.625	1.370	1.676	14MPW-R150	38.30
2"	1.750	1.870	2.192	14MPW-R200	48.60
2½"	1.750	2.370	2.708	14MPW-R250	67.40
3"	1.813	2.870	3.224	14MPW-R300	88.80
4"	2.125	3.834	4.256	14MPW-R400	157.40
6"	2.500	5.758	6.192	14MPW-R600	997.60

3 Roll-on Expanding Ferrules - 14RMP

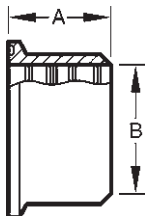

For use when modifying or repairing existing on-site farm milk handling systems.

Tube OD	Dimensions		304 Stainless Steel		316L Stainless Steel	
	A	B	Part #	Price/E	Part #	Price/E
1"	.750	1.005	14RMP-G100	\$9.35	14RMP-R100	\$42.10
1½"	1.125	1.505	14RMP-G150	11.85	14RMP-R150	26.55
2"	1.312	2.005	14RMP-G200	15.60	14RMP-R200	40.20
2½"	1.375	2.505	14RMP-G250	20.95	14RMP-R250	128.25
3"	1.437	3.005	14RMP-G300	24.75	14RMP-R300	113.65
4"	1.500	4.005	14RMP-G400	38.50	14RMP-R400	221.90

3 Reducing Ferrules - B31WMP

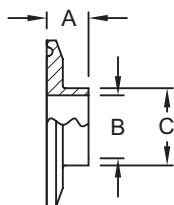

Tube OD	Dimensions			304 Stainless Steel	
	A	B	C	Part #	Price/E
2" x 1"	.500	.870	1.000	B31WMP-G200100	\$140.65
2½" x 1½"	.500	1.370	1.500	B31WMP-G250150	298.15
2½" x 2"	.500	1.870	2.000	B31WMP-G250200	300.70
3" x 2"	.500	1.870	2.000	B31WMP-G300200	362.45
4" x 2"	.625	1.870	2.000	B31WMP-G400200	476.80
4" x 3"	.625	2.870	3.000	B31WMP-G400300	655.25

Clamp Caps

End Caps - 16AMP

- Specify if you are using a piping system or a tubing system when ordering.

Tube OD	Dimensions		304 Stainless Steel		316L Stainless Steel	
	A	B	Part #	Price/E	Part #	Price/E
1/2" - 3/4"	.187	.992	16AMP-G50-75	\$5.90	16AMP-R50-75	\$9.20
1" - 1 1/2"	.250	1.984	16AMP-G100-150	8.55	16AMP-R100-150	10.45
2"	.250	2.516	16AMP-G200	9.35	16AMP-R200	13.60
2 1/2"	.250	3.047	16AMP-G250	14.05	16AMP-R250	19.70
3"	.250	3.579	16AMP-G300	19.25	16AMP-R300	26.70
4"	.312	4.682	16AMP-G400	35.80	16AMP-R400	51.25
5"	.312	5.687	16AMP-G500	525.00	16AMP-R500	792.30
6"	.437	6.570	16AMP-G600	140.65	16AMP-R600	173.65
8"	.437	8.570	16AMP-G800	312.05	16AMP-R800	388.75
10"	.437	10.570	16AMP-G1000	501.25	16AMP-R1000	984.05
12"	.437	12.750	16AMP-G1200	693.70	16AMP-R1200	1333.25



Thermometer Caps - B23BMP

Tube OD	Dimensions			304 Stainless Steel		316L Stainless Steel	
	A	B	C *	Part #	Price/E	Part #	Price/E
1/2"	.500	.993	1/4 NPT	---	---	B23BMP-R5014	\$216.25
3/4"	.500	.993	1/4 NPT	---	---	B23BMP-R7514	240.30
1"	.625	1.984	1/2 NPT	B23BMP-G100	\$39.60	B23BMP-R100	50.25
1 1/2"	.625	1.984	3/4 NPT	B23BMP-G150	34.70	B23BMP-R150	50.25
2"	.625	2.516	3/4 NPT	B23BMP-G200	52.15	B23BMP-R200	66.70
2 1/2"	.625	3.047	3/4 NPT	B23BMP-G250	68.20	B23BMP-R250	108.20
3"	.625	3.579	3/4 NPT	B23BMP-G300	89.75	B23BMP-R300	116.00
4"	.625	4.682	3/4 NPT	B23BMP-G400	135.35	B23BMP-R400	179.50

* other NPT tap sizes available

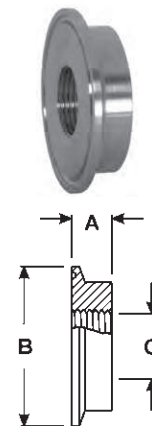

Sanitary Fittings

Clamp Adapters

Tygon Hose Adapters - 14MPHT

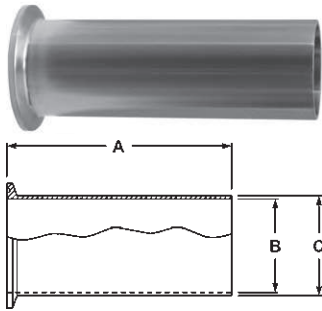

Tube OD	Dimensions			316L Stainless Steel	
	A	B	C	Part #	Price/E
3/4"	4.000	.620	.750	14MPHT-R75	\$400.25
1"	4.500	.870	1.000	14MPHT-R100	71.75
1 1/2"	4.500	1.370	1.500	14MPHT-R150	71.75
2"	4.500	1.870	2.000	14MPHT-R200	78.90
2 1/2"	4.500	2.370	2.500	14MPHT-R250	105.25
3"	4.500	2.870	3.000	14MPHT-R300	131.30
4"	4.625	3.834	4.000	14MPHT-R400	210.60

Rubber Hose Adapters - 14MPHR

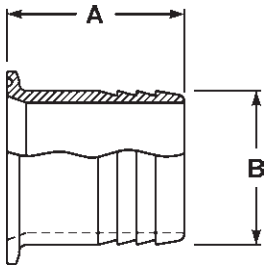

Tube OD	Hose Size	Dimensions		304 Stainless Steel		316L Stainless Steel	
		A	B	Part #	Price/E	Part #	Price/E
1/2"	1/4"	1.500	.250	---	---	14MPHR-R5025	136.40
1/2"	1/2"	1.500	.500	---	---	14MPHR-R50	89.90
1/2"	3/4"	1.500	.750	---	---	14MPHR-R5075	136.40
3/4"	1/4"	1.500	.250	---	---	14MPHR-R7525	112.45
3/4"	3/8"	1.500	.375	---	---	14MPHR-R75375	112.45
3/4"	1/2"	1.500	.500	---	---	14MPHR-R7550	112.45
3/4"	3/4"	1.500	.750	---	---	14MPHR-R75	94.00
1"	3/8"	1.500	.375	---	---	14MPHR-R100375	204.30
1"	1/2"	1.500	.500	14MPHR-G10050	\$158.45	14MPHR-R10050	196.20
1"	3/4"	1.688	.750	14MPHR-G10075	158.45	14MPHR-R10075	232.05
1"	1"	1.688	1.000	14MPHR-G100	42.50	14MPHR-R100	180.95
1-1/2"	1/2"	1.500	.500	14MPHR-G15050	122.35	14MPHR-R15050	204.10
1-1/2"	5/8"	1.500	.625	---	---	14MPHR-R150625	204.10
1-1/2"	3/4"	1.500	.750	14MPHR-G15075	122.35	14MPHR-R15075	204.10
1-1/2"	1"	1.687	1.000	14MPHR-G150100	115.05	14MPHR-R150100	171.85
1-1/2"	1-1/2"	1.689	1.500	14MPHR-G150	47.10	14MPHR-R150	153.00
2"	1-1/2"	2.312	1.500	14MPHR-G200150	223.20	14MPHR-R200150	324.30
2"	2"	2.313	2.000	14MPHR-G200	67.25	14MPHR-R200	148.85
2-1/2"	2-1/2"	2.344	2.500	14MPHR-G250	95.55	14MPHR-R250	260.90
3"	3"	3.094	3.000	14MPHR-G300	113.10	14MPHR-R300	332.70
4"	4"	3.406	4.000	14MPHR-G400	151.95	14MPHR-R400	736.15
6"	6"	3.406	6.000	14MPHR-G600	1422.80	14MPHR-R600	1843.85

304 Brewery Hose Barb Adapters - 14MPHRL

- suitable for use with band clamps

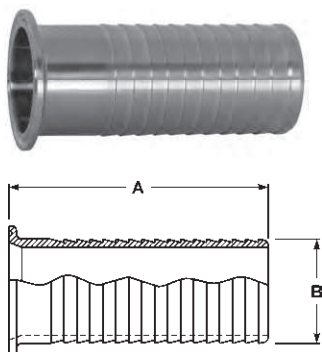

Tube OD	Hose Size	Dimensions		304 Stainless Steel	
		A	B	Part #	Price/E
1"	1"	3.500	1.030	14MPHRL100	\$56.60
1 1/2"	1 1/2"	5.000	1.030	14MPHRL150	64.20
2"	2"	5.000	2.030	14MPHRL200	82.15
2 1/2"	2 1/2"	5.500	2.545	14MPHRL250	100.30
3"	3"	5.500	3.030	14MPHRL300	132.05
4"	4"	5.500	4.030	14MPHRL400	183.40

SAFETY ALERT

Use of PVC tubing requires special techniques to prevent leakage. All assembly work must be done with heated tube. Cold durometer is 90 as opposed to rubber hose at 65 to 70 durometer. Banding buckles must be at 180° from one another.

Clamp Adapters

Clamp x Male NPT Adapters - 21MP

Tube OD	Thread Size	Dimensions		304 Stainless Steel		316L Stainless Steel	
		A	B	Part #	Price/E	Part #	Price/E
1/2"	1/4"	2.000	.595	---	---	21MP-R5025	\$85.80
1/2"	3/8"	2.000	.600	---	---	21MP-R50375	85.80
1/2"	1/2"	1.625	.782	---	---	21MP-R50	78.30
1/2"	3/4"	2.000	.794	---	---	21MP-R5075	117.00
3/4"	1/4"	2.000	.595	---	---	21MP-R7525	95.35
3/4"	3/8"	2.000	.600	---	---	21MP-R75375	189.20
3/4"	1/2"	2.000	.782	---	---	21MP-R7550	95.35
3/4"	3/4"	1.787	.794	---	---	21MP-R75	66.35
1"	1/2"	2.187	.782	21MP-G10050	\$102.25	21MP-R10050	147.85
1"	3/4"	2.187	.794	21MP-G10075	102.25	21MP-R10075	147.85
1"	1"	2.250	.985	21MP-G100	98.60	21MP-R100	115.50
1"	1-1/4"	2.438	1.009	21MP-G100125	203.75	21MP-R100125	230.80
1"	1-1/2"	2.438	1.025	21MP-G100150	203.75	21MP-R100150	221.10
1"	2"	2.625	1.058	21MP-G100200	339.20	21MP-R100200	425.85
1-1/2"	3/8"	2.187	.600	21MP-G150375	199.75	21MP-R150375	236.50
1-1/2"	1/2"	2.187	.782	21MP-G15050	158.15	21MP-R15050	173.00
1-1/2"	3/4"	2.187	.794	21MP-G15075	164.95	21MP-R15075	179.50
1-1/2"	1"	2.437	.985	21MP-G150100	101.80	21MP-R150100	111.55
1-1/2"	1-1/4"	2.438	1.009	21MP-G150125	179.80	21MP-R150125	196.40
1-1/2"	1-1/2"	2.250	1.025	21MP-G150	97.60	21MP-R150	113.95
1-1/2"	2"	2.625	1.058	21MP-G150200	227.15	21MP-R150200	373.15
2"	1/2"	2.187	.782	21MP-G20050	379.35	21MP-R20050	431.95
2"	3/4"	2.188	.794	21MP-G20075	318.15	21MP-R20075	388.55
2"	1"	2.469	.985	21MP-G200100	247.70	21MP-R200100	361.20
2"	1-1/2"	2.625	1.009	21MP-G200150	117.15	21MP-R200150	159.90
2"	2"	2.638	1.058	21MP-G200	117.90	21MP-R200	167.75
2-1/2"	1/2"	2.781	.782	21MP-G25050	590.95	21MP-R25050	1247.90
2-1/2"	1"	2.781	.782	21MP-G250100	542.25	21MP-R250100	701.20
2-1/2"	1-1/2"	2.781	1.025	21MP-G250150	416.20	21MP-R250150	498.15
2-1/2"	2"	2.781	1.058	21MP-G250200	369.20	21MP-R250200	498.15
2-1/2"	2-1/2"	2.875	1.571	21MP-G250	357.20	21MP-R250	382.60
3"	1-1/2"	3.000	1.009	21MP-G300150	601.35	21MP-R300150	848.80
3"	2"	3.000	1.058	21MP-G300200	601.35	21MP-R300200	848.80
3"	3"	3.070	1.634	21MP-G300	203.95	21MP-R300	294.25
4"	4"	3.155	1.734	21MP-G400	289.70	21MP-R400	740.95

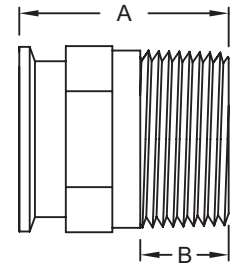

Clamp Adapters

Clamp x Female NPT Adapters - 22MP

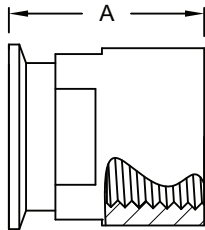

Tube OD	Thread Size	Dimension A	304 Stainless Steel		316L Stainless Steel	
			Part #	Price/E	Part #	Price/E
1/2"	1/4"	1.500	---	---	22MP-R5025	\$66.50
1/2"	3/8"	1.500	---	---	22MP-R50375	202.10
1/2"	1/2"	1.500	---	---	22MP-R50	77.90
1/2"	3/4"	1.625	---	---	22MP-R5075	202.10
3/4"	1/4"	1.500	---	---	22MP-R7525	193.20
3/4"	1/2"	1.500	---	---	22MP-R7550	193.20
3/4"	3/4"	1.625	---	---	22MP-R75	76.35
1"	1/4"	1.625	---	---	22MP-R10025	269.60
1"	1/2"	1.625	22MP-G10050	\$167.50	22MP-R10050	228.10
1"	3/4"	1.625	22MP-G10075	227.15	22MP-R10075	261.00
1"	1"	1.625	22MP-G100	94.40	22MP-R100	125.35
1"	1-1/4"	1.625	---	---	22MP-R100125	387.50
1-1/2"	1/2"	1.625	22MP-G15050	224.85	22MP-R15050	265.95
1-1/2"	3/4"	1.625	22MP-G15075	168.65	22MP-R15075	254.45
1-1/2"	1"	1.625	22MP-G150100	87.25	22MP-R150100	107.50
1-1/2"	1-1/2"	2.250	22MP-G150	98.45	22MP-R150	132.20
1-1/2"	2"	2.250	22MP-G150200	308.55	22MP-R150200	365.25
2"	1"	1.687	22MP-G200100	425.10	22MP-R200100	429.65
2"	1-1/2"	1.656	22MP-G200150	123.50	22MP-R200150	417.35
2"	2"	2.344	22MP-G200	123.65	22MP-R200	165.00
2"	2-1/2"	2.406	22MP-G200250	517.00	---	---
2-1/2"	2"	1.719	22MP-G250200	583.10	22MP-R250200	681.85
2-1/2"	2-1/2"	2.093	22MP-G250	342.85	22MP-R250	586.65
3"	2"	2.187	---	---	22MP-R300200	1143.95
3"	2-1/2"	2.187	22MP-G300250	701.45	22MP-R300250	967.50
3"	3"	2.187	22MP-G300	202.35	22MP-R300	304.85
4"	4"	3.652	22MP-G400	558.45	22MP-R400	727.30

Transition Fittings *

* for all other cam and groove options see section A

Cam and Groove Adapter x Clamp End



- does not have sanitary polish

Size	316 Stainless Steel	
	Part #	Price/E
1 1/2"	RE150SE	\$162.75
2"	RE200SE	165.80
3"	RE300SE	378.00

Cam and Groove Coupler x Clamp End



- does not have sanitary polish

Size	316 Stainless Steel	
	Part #	Price/E
1 1/2"	RC150SE	\$270.00
2"	RC200SE	310.50
3"	RC300SE	490.00

Dixon Weld to Tube Cam and Groove *

- * for all other cam and groove options see section A
- 316 stainless steel investment casting
- designed to be butt welded to standard sanitary tubing
- does not have sanitary polish

Adapter x Weld to Tube End



Size	316 Stainless Steel	
	Part #	Price/E
1"	RE100BT	\$130.00
1 1/2"	RE150BT	143.00
2"	RE200BT	158.00
3"	RE300BT	357.00

Boss-Lock Coupler x Weld to Tube End



Size	316 Stainless Steel	
	Part #	Price/E
1"	RC100BT	\$210.00
1 1/2"	RC150BT	243.00
2"	RC200BT	280.00
3"	RC300BT	441.00

Clamp Elbows

90° Clamp Elbows - B2CMP

Tube OD	Dimensions		304 Stainless Steel		316L Stainless Steel	
	A	R	Part #	Price/E	Part #	Price/E
1/2"	1.625	1.125	---	---	B2CMP-R50	\$107.15
3/4"	1.625	1.125	---	---	B2CMP-R75	123.20
1"	2.000	1.500	B2CMP-G100	\$50.65	B2CMP-R100	65.50
1 1/2"	2.750	2.250	B2CMP-G150	52.40	B2CMP-R150	70.30
2"	3.500	3.000	B2CMP-G200	69.35	B2CMP-R200	93.00
2 1/2"	4.250	3.750	B2CMP-G250	94.25	B2CMP-R250	132.70
3"	5.000	4.500	B2CMP-G300	133.50	B2CMP-R300	184.55
4"	6.625	6.000	B2CMP-G400	225.70	B2CMP-R400	278.85
6"	9.875	9.000	B2CMP-G600	1213.35	B2CMP-R600	1383.45

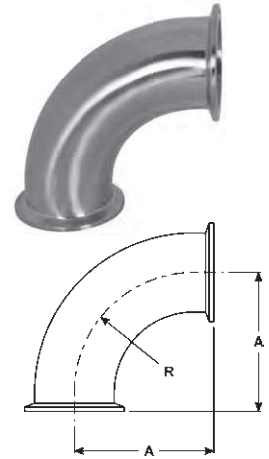

45° Clamp Elbows - B2KMP

Tube OD	Dimensions		304 Stainless Steel		316L Stainless Steel	
	A	R	Part #	Price/E	Part #	Price/E
1/2"	.996	1.125	---	---	B2KMP-R50	\$141.65
3/4"	.966	1.125	---	---	B2KMP-R75	137.15
1"	1.125	1.500	B2KMP-G100	\$44.70	B2KMP-R100	59.35
1 1/2"	1.437	2.250	B2KMP-G150	48.25	B2KMP-R150	65.25
2"	1.750	3.000	B2KMP-G200	67.95	B2KMP-R200	84.65
2 1/2"	2.062	3.750	B2KMP-G250	92.25	B2KMP-R250	121.95
3"	2.375	4.500	B2KMP-G300	124.80	B2KMP-R300	159.40
4"	3.125	6.000	B2KMP-G400	203.90	B2KMP-R400	257.95
6"	4.625	9.000	B2KMP-G600	1044.25	B2KMP-R600	1078.05

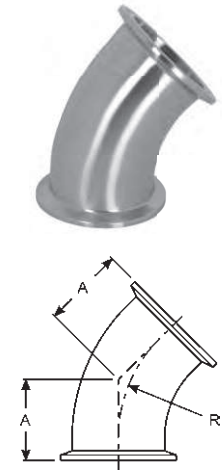

Sanitary Fittings

90° Clamp x Plain Bevel Seat with Hex Nut Elbows - B2FMP-14

Tube OD	Dimensions		304 Stainless Steel	
	A	B	Part #	Price/E
2"	3.750	3.500	B2FMP-14-G200	\$246.25
2 1/2"	5.375	4.250	B2FMP-14-G250	280.50
3"	5.406	5.000	B2FMP-14-G300	391.65



Clamp Tees

3 Short Outlet Clamp Tees - B7MPS

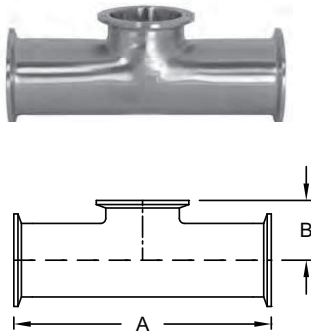

Tube OD	Dimensions		316L Stainless Steel	
	A	B	Part #	Price/E
1½"	5.500	1.375	B7MPS-R150	\$275.05
2"	7.000	1.625	B7MPS-R200	318.15
2½"	7.000	1.875	B7MPS-R250	341.10

3 Clamp Tees - B7MP

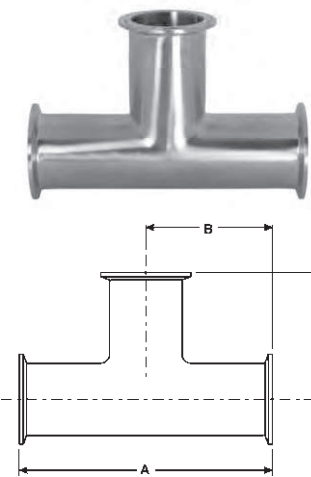

Tube OD	Dimensions		304 Stainless Steel		316L Stainless Steel	
	A	B	Part #	Price/E	Part #	Price/E
½"	4.750	2.375	---	---	B7MP-R50	\$584.10
¾"	5.000	2.500	---	---	B7MP-R75	516.55
1"	4.750	2.375	B7MP-G100	\$82.30	B7MP-R100	111.25
1½"	5.500	2.750	B7MP-G150	92.60	B7MP-R150	128.35
2"	7.000	3.500	B7MP-G200	114.70	B7MP-R200	149.00
2½"	7.000	3.500	B7MP-G250	146.55	B7MP-R250	199.80
3"	7.500	3.750	B7MP-G300	198.85	B7MP-R300	278.80
4"	9.000	4.500	B7MP-G400	287.95	B7MP-R400	396.15
6"	13.000	6.500	B7MP-G600	2049.95	B7MP-R600	2587.45
8"	15.750	7.875	B7MP-G800	2132.85	B7MP-R800	4628.70

3 Clamp Reducing Tees - B7RMP

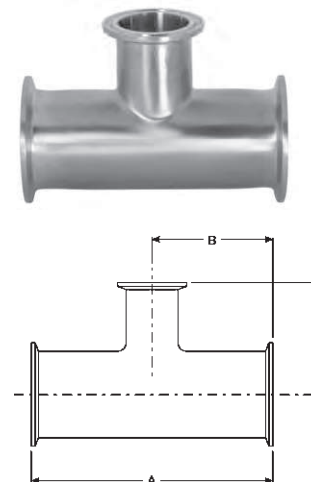

Tube OD	Dimensions			304 Stainless Steel		316L Stainless Steel	
	A	B	C	Part #	Price/E	Part #	Price/E
1" x ¾"	5.250	2.625	2.625	---	---	B7RMP-R10075	\$473.05
1½" x ½"	5.750	2.875	2.875	---	---	B7RMP-R15050	482.10
1½" x 1"	4.312	2.156	1.875	---	---	B7RMP-R150100	199.90
2" x ½"	6.750	3.375	3.125	---	---	B7RMP-R20050	687.05
2" x ¾"	6.750	3.375	3.125	---	---	B7RMP-R20075	722.50
2" x 1"	5.125	2.562	2.125	B7RMP-G200100	\$223.05	B7RMP-R200100	236.35
2" x 1½"	5.688	2.844	2.406	B7RMP-G200150	170.65	B7RMP-R200150	257.00
2½" x 1½"	5.688	2.844	2.656	B7RMP-G250150	247.40	B7RMP-R250150	345.65
2½" x 2"	6.188	3.093	2.812	B7RMP-G250200	213.05	B7RMP-R250200	249.90
3" x 1½"	6.188	3.093	2.906	B7RMP-G300150	303.40	B7RMP-R300150	467.75
3" x 2"	6.188	3.093	3.063	B7RMP-G300200	256.00	B7RMP-R300200	383.10
4" x 1½"	8.125	4.063	3.406	B7RMP-G400150	408.75	---	---
4" x 2"	8.125	4.063	3.563	B7RMP-G400200	408.75	---	---

Clamp Reducers

Clamp Concentric Reducers - B3114MP

Tube OD	Dimension A	304 Stainless Steel		316L Stainless Steel	
		Part #	Price/E	Part #	Price/E
1" x 1/2"	3.000	---	---	B3114MP-R10050	\$277.05
1" x 3/4"	2.000	---	---	B3114MP-R10075	237.00
1 1/2" x 1/2"	5.000	---	---	B3114MP-R15050	357.65
1 1/2" x 3/4"	4.000	---	---	B3114MP-R15075	357.55
1 1/2" x 1"	3.000	B3114MP-G150100	\$84.30	B3114MP-R150100	92.25
2" x 3/4"	6.000	---	---	B3114MP-R20075	660.55
2" x 1"	5.000	B3114MP-G200100	115.55	B3114MP-R200100	139.15
2" x 1 1/2"	3.000	B3114MP-G200150	88.60	B3114MP-R200150	98.15
2 1/2" x 1 1/2"	5.000	B3114MP-G250150	123.95	B3114MP-R250150	132.80
2 1/2" x 2"	3.000	B3114MP-G250200	107.20	B3114MP-R250200	121.45
3" x 1 1/2"	7.000	B3114MP-G300150	210.70	B3114MP-R300150	257.50
3" x 2"	5.000	B3114MP-G300200	144.60	B3114MP-R300200	167.20
3" x 2 1/2"	3.000	B3114MP-G300250	132.20	B3114MP-R300250	146.90
4" x 1 1/2"	11.125	B3114MP-G400150	503.75	B3114MP-R400150	630.45
4" x 2"	9.125	B3114MP-G400200	286.85	B3114MP-R400200	342.30
4" x 2 1/2"	7.125	B3114MP-G400250	325.90	B3114MP-R400250	361.75
4" x 3"	5.125	B3114MP-G400300	194.50	B3114MP-R400300	219.10
6" x 4"	7.000	B3114MP-G600400	829.15	---	---

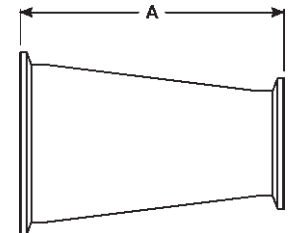

Clamp Eccentric Reducers - B3214MP

Tube OD	Dimension A	304 Stainless Steel		316L Stainless Steel	
		Part #	Price/E	Part #	Price/E
1 1/2" x 1"	3.000	B3214MP-G150100	\$95.20	B3214MP-R150100	\$140.55
2" x 1"	5.000	B3214MP-G200100	224.45	B3214MP-R200100	398.75
2" x 1 1/2"	3.000	B3214MP-G200150	108.30	B3214MP-R200150	182.10
2 1/2" x 1 1/2"	5.000	B3214MP-G250150	149.45	B3214MP-R250150	254.90
2 1/2" x 2"	3.000	B3214MP-G250200	125.85	B3214MP-R250200	233.90
3" x 1 1/2"	7.000	B3214MP-G300150	242.85	B3214MP-R300150	305.15
3" x 2"	5.000	B3214MP-G300200	175.45	B3214MP-R300200	216.30
3" x 2 1/2"	3.000	B3214MP-G300250	212.65	B3214MP-R300250	222.25
4" x 2"	9.125	B3214MP-G400200	362.80	B3214MP-R400200	397.65
4" x 2 1/2"	7.125	B3214MP-G400250	353.35	B3214MP-R400250	465.60
4" x 3"	5.125	B3214MP-G400300	258.05	B3214MP-R400300	387.20
6" x 3"	6.875	B3214MP-G600300	1114.10	---	---
6" x 4"	7.000	B3214MP-G600400	1213.55	---	---

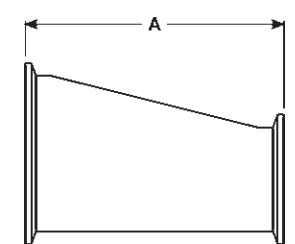

Sanitary Fittings

Clamp Crosses

Clamp Crosses - B9MP

Tube OD	Dimensions		304 Stainless Steel		316L Stainless Steel	
	A	B	Part #	Price/E	Part #	Price/E
1"	4.750	2.375	B9MP-G100	\$275.25	B9MP-R100	\$304.70
1 1/2"	5.500	2.750	B9MP-G150	316.05	B9MP-R150	324.25
2"	7.000	3.500	B9MP-G200	343.00	B9MP-R200	373.80
3"	7.500	3.750	B9MP-G300	684.45	B9MP-R300	722.00
4"	9.000	4.500	B9MP-G400	857.75	B9MP-R400	1163.30

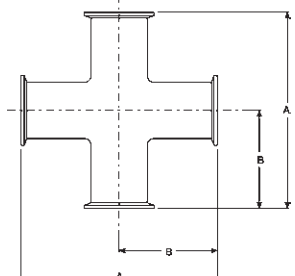

Miscellaneous Configurations

Crowder Supply Co., Inc. • 8495 Roslyn St., Commerce City, CO 80022 • Toll Free: 888-883-5144 • www.CrowderSupply.com

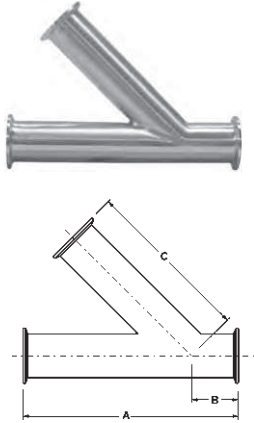

3 Clamp Laterals - B28AMP

Tube OD	Dimensions			316L Stainless Steel	
	A	B	C	Part #	Price/E
1"	7.000	1.500	5.500	B28AMP-R100	\$659.60
1½"	8.375	1.688	6.688	B28AMP-R150	672.10
2"	9.750	2.125	7.625	B28AMP-R200	697.40
3"	11.750	2.375	9.375	B28AMP-R300	1081.15
4"	14.062	2.640	11.312	B28AMP-R400	1896.60

3 Clamp True Y - B28BMP

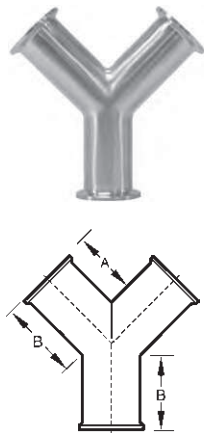

Tube OD	Dimensions		316L Stainless Steel	
	A	B	Part #	Price/E
1"	2.500	2.938	B28BMP-R100	\$621.65
1½"	2.500	2.938	B28BMP-R150	672.10
2"	3.125	3.750	B28BMP-R200	697.40
3"	4.500	5.375	B28BMP-R300	1081.15
4"	6.000	6.000	B28BMP-R400	1859.45

3 Clamp 180° Return Bends - B2WUMP

Bends are the standard 1.5 x tube diameter.

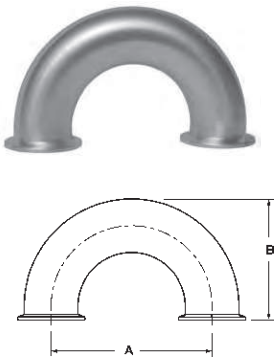

Tube OD	Dimensions		316L Stainless Steel	
	A	B	Part #	Price/E
1"	3.000	2.500	B2WUMP-R100	\$322.20
1½"	4.500	3.500	B2WUMP-R150	352.15
2"	6.000	4.500	B2WUMP-R200	469.60
3"	9.000	6.500	B2WUMP-R300	821.65
4"	12.000	8.625	B2WUMP-R400	1136.35

Clamp Gaskets

Gasket material approved by  (3A), USDA and complies with FDA's 21CFR177.2600 and 1550. PSI Service Ratings for the sanitary clamps *DO NOT APPLY* to connections (1" and above) using any PTFE gaskets, due to the potential for cold flow under normal operating conditions. PTFE gaskets, when used with any clamp, are likely to leak at pressures far below the published service ratings. This restriction *does not apply* to the fractionally sized 1/2" and 3/4" connections, due to their recessed, fully contained design.



Mini

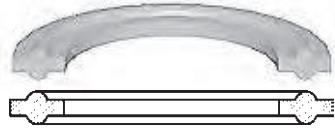

Standard - type 1

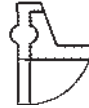

Flanged - type 2

Buna-N Clamp Gaskets - Black

Size	Part #	Price/E
1/2"	42MP-U50	\$1.80
3/4"	42MP-U75	2.60
1"	40MP-U100	0.85
1 1/2"	40MP-U150	0.65
2"	40MP-U200	0.85
2 1/2"	40MP-U250	0.85
3"	40MP-U300	1.05
4"	40MP-U400	1.80
5"	40MP-U500	8.90
6"	40MP-U600	19.70
8"	40MP-U800	28.30



Type 1 - Standard
1/2" - 3/4"



Type 1 - Standard
1" and larger

- color code: red dot
- meets 21CFR 177.2600

Buna-N Clamp Gaskets - White

Size	Part #	Price/E
1/2"	42MP-UW50	\$3.00
3/4"	42MP-UW75	3.40
1"	40MP-UW100	1.50
1 1/2"	40MP-UW150	1.40
2"	40MP-UW200	1.65
2 1/2"	40MP-UW250	1.70
3"	40MP-UW300	1.80
4"	40MP-UW400	3.25
6"	40MP-UW600	32.50



Type 1 - Standard
1/2" - 3/4"



Type 1 - Standard
1" and larger

- color code: red dot
- meets 21CFR 177.2600

EPDM Clamp Gaskets - Black

Size	Part #	Price/E
1/2"	42MP-E50	\$2.20
3/4"	42MP-E75	2.45
1"	40MP-E100	2.30
1 1/2"	40MP-E150	2.20
2"	40MP-E200	2.30
2 1/2"	40MP-E250	2.90
3"	40MP-E300	3.40
4"	40MP-E400	3.70
6"	40MP-E600	22.50



Type 1 - Standard
1/2" - 3/4"



Type 1 - Standard
1" and larger

- color code: three green dots
- peroxide cured
- meets 21CFR 177.2600
- passed USP Class VI Cytotoxicity testing

Clamp Gaskets**FKM (Viton®) Clamp Gaskets - Black**Type 1 - Standard
1/2" - 3/4"Type 1 - Standard
1" and larger

- color code: one white dot, one yellow dot
- peroxide cured
- meets 21CFR 177.2600
- passed USP Class VI Cytotoxicity testing

Size	Part #	Price/E
1/2"	42MP-SFY50	\$5.75
3/4"	42MP-SFY75	6.30
1"	40MP-SFY100	6.30
1 1/2"	40MP-SFY150	4.55
2"	40MP-SFY200	4.80
2 1/2"	40MP-SFY250	8.75
3"	40MP-SFY300	11.05
4"	40MP-SFY400	16.30
6"	40MP-SFY600	54.75

Silicone Clamp Gaskets - WhiteType 1 - Standard
1/2" - 3/4"Type 1 - Standard
1" and larger

- color code: pink dot
- peroxide cured
- meets 21CFR 177.2600
- passed USP Class VI Cytotoxicity testing

Size	Part #	Price/E
1/2"	42MP-XW50	\$3.00
3/4"	42MP-XW75	3.40
1"	40MP-XW100	3.25
1 1/2"	40MP-XW150	2.75
2"	40MP-XW200	3.25
2 1/2"	40MP-XW250	4.40
3"	40MP-XW300	4.85
4"	40MP-XW400	5.75
6"	40MP-XW600	36.95

Silicone Clamp Gaskets - ClearType 1 - Standard
1/2" - 3/4"Type 1 - Standard
1" and larger

- color code: pink dot
- peroxide cured
- meets 21CFR 177.2600
- passed USP Class VI Cytotoxicity testing

Size	Part #	Price/E
1/2"	42MP-XC50	\$3.00
3/4"	42MP-XC75	3.40
1"	40MP-XC100	4.40
1 1/2"	40MP-XC150	4.40
2"	40MP-XC200	4.55
2 1/2"	40MP-XC250	5.50
3"	40MP-XC300	6.30
4"	40MP-XC400	8.75

PTFE (Teflon®) Clamp Gaskets - WhiteType 1 - Standard
1/2" - 3/4"Type 1 - Standard
1" and larger

- color code: no dot
- meets 21CFR 177.1550
- passed USP Class VI Cytotoxicity testing
- not recommended for use with bolted clamps

Size	Part #	Price/E
1/2"	42MP-G50	\$3.40
3/4"	42MP-G75	3.15
1"	40MP-G100	2.85
1 1/2"	40MP-G150	2.05
2"	40MP-G200	2.45
2 1/2"	40MP-G250	3.15
3"	40MP-G300	3.40
4"	40MP-G400	4.80
5"	40MP-G500	79.35
6"	40MP-G600	43.65
8"	40MP-G800	100.05
10"	40MP-G1000	179.00
12"	40MP-G1200	306.85

new

Metal Detectable Clamp Gaskets

Metal detectable gaskets are impregnated with stainless steel particles. The addition of stainless steel allows a gasket or gasket pieces to be found with metal detection equipment.

Buna-N

Size	Part #	Price/E
1"	40MP-UZ100	\$3.75
1½"	40MP-UZ150	3.50
2"	40MP-UZ200	3.80
2½"	40MP-UZ250	5.90
3"	40MP-UZ300	6.40
4"	40MP-UZ400	6.45



Type 1 - Standard
1" and larger

- minimum temperature: **-20°F**
- maximum temperature: **212°F**
- good general use where temperature extremes do not exist

EPDM

Size	Part #	Price/E
1"	40MP-EZ100	\$5.25
1½"	40MP-EZ150	5.10
2"	40MP-EZ200	5.35
2½"	40MP-EZ250	6.95
3"	40MP-EZ300	7.70
4"	40MP-EZ400	10.20



Type 1 - Standard
1" and larger

- minimum temperature: **-70°F**
- maximum temperature: **310°F**
- excellent base, steam and water resistant

Viton®

Size	Part #	Price/E
1"	40MP-SFYZ100	\$11.70
1½"	40MP-SFYZ150	11.25
2"	40MP-SFYZ200	11.55
2½"	40MP-SFYZ250	17.40
3"	40MP-SFYZ300	23.60
4"	40MP-SFYZ400	30.50



Type 1 - Standard
1" and larger

- minimum temperature: **-20°F**
- maximum temperature: **410°F**
- provides high acid, steam and heat resistance



Clamp Gaskets

Buna-N Flanged Clamp Gaskets - Black

Type 2 - Flanged
1" and larger

- color code: red dot
- meets 21CFR 177.2600
- not recommended for use with bolted clamps

Size	Part #	Price/E
1"	40MPF-U100	\$2.05
1½"	40MPF-U150	1.80
2"	40MPF-U200	2.05
2½"	40MPF-U250	2.45
3"	40MPF-U300	3.40
4"	40MPF-U400	4.55
6"	40MPF-U600	26.70
8"	40MPF-U800	24.20
10"	40MPF-U1000	91.00
12"	40MPF-U1200	110.85

Buna-N Flanged Clamp Gaskets - White

Type 2 - Flanged
1" and larger

- color code: red dot
- meets 21CFR 177.2600
- passed USP Class VI Cytotoxicity testing
- not recommended for use with bolted clamps

Size	Part #	Price/E
1"	40MPF-UW100	\$3.15
1½"	40MPF-UW150	2.45
2"	40MPF-UW200	2.85
2½"	40MPF-UW250	4.80
3"	40MPF-UW300	4.80
4"	40MPF-UW400	6.70

EPDM Flanged Clamp Gaskets

Type 2 - Flanged
1" and larger

- color code: three green dots
- peroxide cured
- meets 21CFR 177.2600
- passed USP Class VI Cytotoxicity testing
- not recommended for use with bolted clamps

Size	Part #	Price/E
1"	40MPF-E100	\$3.65
1½"	40MPF-E150	3.40
2"	40MPF-E200	3.80
2½"	40MPF-E250	5.60
3"	40MPF-E300	6.05
4"	40MPF-E400	6.55
6"	40MPF-E600	42.60
8"	40MPF-E800	61.85
10"	40MPF-E1000	73.00
12"	40MPF-E1200	77.90

FKM (Viton®) Flanged Clamp Gaskets

Type 2 - Flanged
1" and larger

- color code: one white dot, one yellow dot
- peroxide cured
- meets 21CFR 177.2600
- passed USP Class VI Cytotoxicity testing
- not recommended for use with bolted clamps

Size	Part #	Price/E
1"	40MPF-SFY100	\$11.80
1½"	40MPF-SFY150	8.75
2"	40MPF-SFY200	10.10
2½"	40MPF-SFY250	17.50
3"	40MPF-SFY300	18.30
4"	40MPF-SFY400	21.20
6"	40MPF-SFY600	63.80
8"	40MPF-SFY800	106.35
10"	40MPF-SFY1000	133.65
12"	40MPF-SFY1200	153.45

Clamp Gaskets

Silicone Flanged Clamp Gaskets - White

Size	Part #	Price/E
1"	40MPF-XW100	\$4.95
1½"	40MPF-XW150	4.95
2"	40MPF-XW200	4.95
2½"	40MPF-XW250	6.15
3"	40MPF-XW300	7.35
4"	40MPF-XW400	9.70
6"	40MPF-XW600	57.20
8"	40MPF-XW800	71.15
10"	40MPF-XW1000	84.05
12"	40MPF-XW1200	78.75

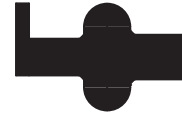

Type 2 - Flanged
1" and larger

- color code: no dot
- peroxide cured
- meets 21CFR 177.2600
- passed USP Class VI Cytotoxicity testing
- not recommended for use with bolted clamps

Buna-N Mesh Screen Clamp Gasket, 316

Size	Part #	Price/E
1"	40MPS-U100	\$47.10
1½"	40MPS-U150	41.45
2"	40MPS-U200	44.35
2½"	40MPS-U250	58.85
3"	40MPS-U300	67.75
4"	40MPS-U400	105.95

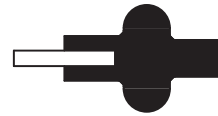

- color code: red dot
- 10 mesh standard, other mesh available-call for details
- meets 21CFR 177.2600

PTFE (Teflon®) Envelope Clamp Gaskets with EPDM

Size	Part #	Price/E
½"	42MP-GRE50	\$9.85
1"	40MP-GRE100	7.35
1½"	40MP-GRE150	6.55
2"	40MP-GRE200	7.35
2½"	40MP-GRE250	8.90
3"	40MP-GRE300	10.40
4"	40MP-GRE400	19.15
6"	40MP-GRE600 new	67.25



- color code: usually not marked
- peroxide cured
- meets 21CFR 177.1550
- passed USP Class VI Cytotoxicity testing

PTFE (Teflon®) Envelope Clamp Gaskets with Viton®

Size	Part #	Price/E
1"	40MP-GR100	\$7.10
1½"	40MP-GR150	6.55
2"	40MP-GR200	7.50
2½"	40MP-GR250	8.90
3"	40MP-GR300	10.40
4"	40MP-GR400	17.70
6"	40MP-GR600	84.80



- color code: Viton® usually not marked
- meets 21CFR 177.1550
- passed USP Class VI Cytotoxicity testing

European Fittings DIN 11851

DIN Round Nut (DIN11857) - 13R

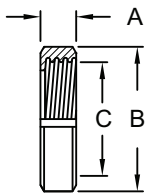

Tube OD	DN Size	Dimensions			304 Stainless Steel	
		A	B	C	Part #	Price/E
1"	25	.83	2.48	2.05	13R-G100DIN	\$40.00
1½"	40	.83	3.07	2.56	13R-G150DIN	49.85
2"	50	.87	3.62	3.07	13R-G200DIN	63.75
2½"	65	.98	4.41	3.74	13R-G250DIN	86.40
3"	80	1.14	5.00	4.33	13R-G300DIN	132.70
4"	100	1.22	5.83	5.12	13R-G400DIN	154.85

DIN Blank Cap - 16AMP

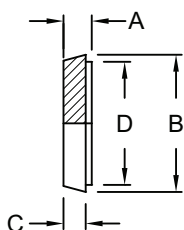

Tube OD	DN Size	Dimensions				316 Stainless Steel	
		A	B	C	D	Part #	Price/E
1"	25	.51	1.73	.39	1.38	16AMP-R100DIN	\$31.65
1½"	40	.51	2.20	.39	1.89	16AMP-R150DIN	51.75
2"	50	.55	2.68	.43	2.40	16AMP-R200DIN	73.75
2½"	65	.63	3.39	.47	3.11	16AMP-R250DIN	130.75
3"	80	.63	3.66	.47	3.39	16AMP-R300DIN	161.25
4"	100	.79	4.76	.59	4.49	16AMP-R400DIN	268.45

DIN Welding Male - 15A

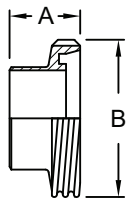

Tube OD	DN Size	Dimensions		316 Stainless Steel	
		A	B	Part #	Price/E
1"	25	1.14	2.04	15A-R100DIN	\$38.25
1½"	40	1.30	2.55	15A-R150DIN	53.45
2"	50	1.38	3.07	15A-R200DIN	65.60
2½"	65	1.57	3.74	15A-R250DIN	103.30
3"	80	1.57	4.09	15A-R300DIN	160.50
4"	100	2.13	5.12	15A-R400DIN	181.35

DIN Welding Liner - 14A

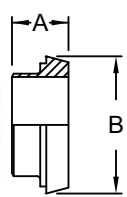

Tube OD	DN Size	Dimensions		316 Stainless Steel	
		A	B	Part #	Price/E
1"	25	.87	1.73	14A-R100DIN	\$26.60
1½"	40	1.02	2.20	14A-R150DIN	37.40
2"	50	1.10	2.68	14A-R200DIN	47.75
2½"	65	1.26	3.39	14A-R250DIN	82.05
3"	80	1.26	3.66	14A-R300DIN	114.05
4"	100	1.73	4.76	14A-R400DIN	145.40

European Fittings

SMS Round Nuts - 13R

Tube OD	DN Size	Dimensions			304 Stainless Steel	
		A	B	C	Part #	Price/E
1"	25	.75	2.01	1.57	13R-G100SMS	\$39.65
1½"	38	.91	2.91	2.38	13R-G150SMS	49.75
2"	51	.94	3.31	2.76	13R-G200SMS	62.30
2½"	63.5	1.10	3.94	3.35	13R-G250SMS	80.75
3"	76	1.18	4.49	3.88	13R-G300SMS	121.10
4"	101.6	1.22	5.43	4.92	13R-G400SMS	146.60

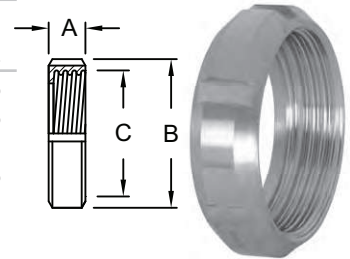

SMS Blank Caps - 16AMP

Tube OD	DN Size	Dimensions				316 Stainless Steel	
		A	B	C	D	Part #	Price/E
1"	25	.300	1.400	.140	1.250	16AMP-R100SMS	\$28.05
1½"	38	.310	2.200	.160	1.890	16AMP-R150SMS	44.70
2"	51	.350	2.560	.150	2.380	16AMP-R200SMS	67.10
2½"	63.5	.350	3.150	.160	2.890	16AMP-R250SMS	101.85
3"	76	.430	3.660	.200	3.410	16AMP-R300SMS	145.65
4"	101.6	.430	4.650	.230	4.430	16AMP-R400SMS	218.25

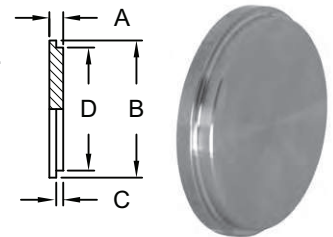

SMS Welding Males - 15A

Tube OD	DN Size	Dimensions		316 Stainless Steel	
		A	B	Part #	Price/E
1"	25	.75	1.57	15A-R100SMS	\$36.35
1½"	38	.91	2.36	15A-R150SMS	46.40
2"	51	.91	2.76	15A-R200SMS	65.15
2½"	63.5	1.06	3.35	15A-R250SMS	119.65
3"	76	1.06	3.88	15A-R300SMS	148.20
4"	101.6	1.18	4.92	15A-R400SMS	177.10

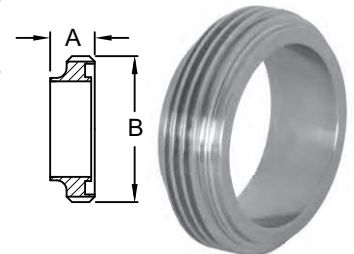

Sanitary Fittings

SMS Welding Liners - 14A

Tube OD	DN Size	Dimensions		316 Stainless Steel	
		A	B	Part #	Price/E
1"	25	.61	1.40	14A-R100SMS	\$24.35
1½"	38	.63	2.17	14A-R150SMS	34.35
2"	51	.67	2.56	14A-R200SMS	42.05
2½"	63.5	.67	3.16	14A-R250SMS	55.35
3"	76	.75	3.66	14A-R300SMS	87.75
4"	101.6	.75	4.65	14A-R400SMS	111.90

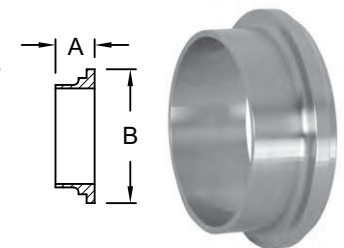

Spanner Wrenches - SP

- for use on DIN or SMS Round Nuts

Used On Sizes	DN Size	A	Nickel Plated Steel	
			Part #	Price/E
1" - 1½"	25-38	11.00	DIN-SMS-60/90SP	\$210.95
2" - 4"	51-101.6	13.00	DIN-SMS90/155SP	643.60

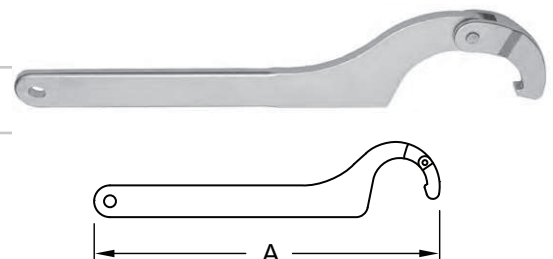

European Fittings

RJT Hex Nuts - 13H

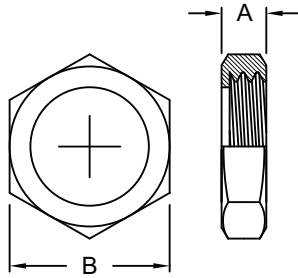

Size	A	B	304 Stainless Steel	
			Part #	Price/E
1"	.87	2.00	13H-G100RJT	\$36.95
1½"	.87	2.56	13H-G150RJT	49.60
2"	.87	3.12	13H-G200RJT	64.55
2½"	.87	3.62	13H-G250RJT	80.40
3"	.87	4.12	13H-G300RJT	98.65
4"	.87	5.12	13H-G400RJT	117.70

RJT Blank Caps - 13RBN

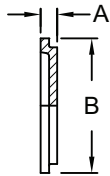

Size	A	B	304 Stainless Steel	
			Part #	Price/E
1"	.32	1.63	13RBN-G100RJT	\$19.95
1½"	.32	2.12	13RBN-G150RJT	30.95
2"	.32	2.62	13RBN-G200RJT	46.25
2½"	.32	3.12	13RBN-G250RJT	72.00
3"	.32	3.63	13RBN-G300RJT	94.85
4"	.32	4.63	13RBN-G400RJT	175.55

RJT Welding Males - 15A

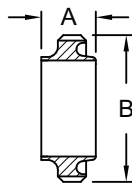

Size	A	B	316 Stainless Steel	
			Part #	Price/E
1"	1.06	1.80	15A-R100RJT	\$44.55
1½"	1.06	2.30	15A-R150RJT	60.50
2"	1.06	2.86	15A-R200RJT	78.10
2½"	1.06	3.36	15A-R250RJT	91.35
3"	1.06	3.86	15A-R300RJT	113.30
4"	1.06	4.86	15A-R400RJT	162.10

RJT Welding Liners - 14A

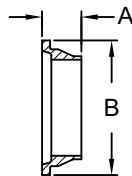

Size	A	B	316 Stainless Steel	
			Part #	Price/E
1"	.77	1.63	14A-R100RJT	\$29.85
1½"	.77	2.13	14A-R150RJT	33.75
2"	.77	2.63	14A-R200RJT	42.35
2½"	.77	3.13	14A-R250RJT	57.70
3"	.77	3.63	14A-R300RJT	67.00
4"	.77	4.63	14A-R400RJT	93.35

RJT Spanner Wrenches - SP

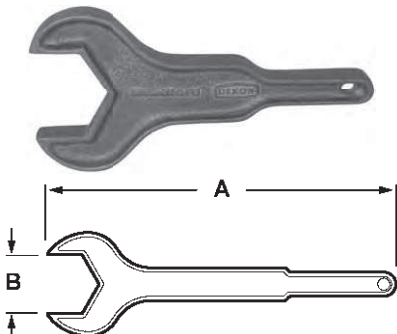

Size	A	B	Aluminum	
			Part #	Price/E
1"	10.00	2.00	RJT-100SP	\$285.20
1½"	11.50	2.56	RJT-150SP	326.60
2"	12.00	3.12	RJT-200SP	383.15
2½"	13.50	3.62	RJT-250SP	500.70
3"	14.50	4.12	RJT-300SP	616.80
4"	17.50	5.12	RJT-400SP	772.15

European Gaskets**DIN Buna-N European Gaskets - Black**

- color code: red dot
- meets 21CFR 177.2600

Size	DN Size	ID	OD	Ht	Part #	Price/E
1"	25	1.18	1.57	.20	40MP-U100DIN	\$7.85
1½"	40	1.65	2.05	.20	40MP-U150DIN	12.45
2"	50	2.13	2.52	.20	40MP-U200DIN	13.00
2½"	65	2.80	3.19	.20	40MP-U250DIN	15.20
3"	80	3.35	3.74	.20	40MP-U300DIN	17.45
4"	100	4.09	4.49	.24	40MP-U400DIN	21.95

**SMS Buna-N European Gaskets - Black**

- color code: red dot
- meets 21CFR 177.2600

Size	DN Size	ID	OD	Part #	Price/E
1"	25	.98	1.26	40MP-U100SMS	\$6.95
1½"	38	1.49	1.89	40MP-U150SMS	2.35
2"	51	2.00	2.40	40MP-U200SMS	2.50
2½"	63.5	2.50	2.89	40MP-U250SMS	2.70
3"	76	2.99	3.39	40MP-U300SMS	4.95
4"	101.6	4.09	4.49	40MP-U400SMS	20.75

**RJT Buna-N European Gaskets - Black**

- color code: red dot
- meets 21CFR 177.2600

Size	ID	Ø	Part #	Price/E
1"	1.06	.25	40MP-U100RJT	\$8.75
1½"	1.56	.25	40MP-U150RJT	9.45
2"	2.06	.25	40MP-U200RJT	11.00
2½"	2.56	.25	40MP-U250RJT	14.20
3"	3.06	.25	40MP-U300RJT	17.75
4"	4.06	.25	40MP-U400RJT	48.20

Sanitary
Fittings

Bevel Seat Hex Nuts

Hex Union Nuts - 13H

• 400 PSI maximum

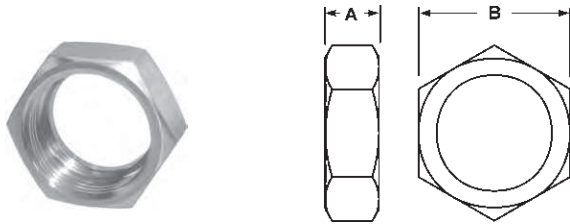

Tube OD	Dimensions		304 Stainless Steel	
	A	B	Part #	Price/E
1"	.906	1.812	13H-G100	\$20.15
1½"	.968	2.406	13H-G150	28.40
2"	1.062	3.000	13H-G200	36.50
2½"	1.187	3.594	13H-G250	54.55
3"	1.281	4.188	13H-G300	72.50
4"	1.500	5.438	13H-G400	126.00

Bevel Seat Hex Wrenches

Single Sided Hex Wrenches - 25H

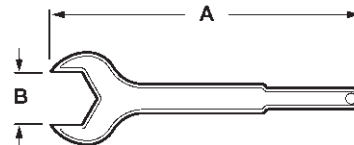

Tube OD	Dimensions		Weight Lbs.	Aluminum	
	A	B		Part #	Price/E
1"	10.500	1.812	.64	25H-100	\$51.30
1½"	12.000	2.406	.86	25H-150	53.00
2"	14.000	3.000	1.76	25H-200	65.00
2½"	16.250	3.594	2.40	25H-250	95.95
3"	18.500	4.188	3.04	25H-300	133.25
4"	19.500	5.438	3.62	25H-400	169.70

Two Sided Hex Wrenches - 25H

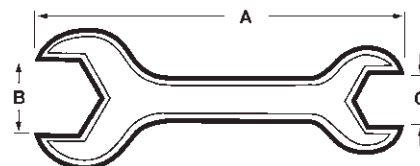

Tube OD	Dimensions			Weight Lbs.	Aluminum	
	A	B	C		Part #	Price/E
1½" x 1"	12.000	2.406	1.812	1.00	25H-150100	\$95.80
2" x 1½"	14.000	3.000	2.406	1.75	25H-200150	107.00
2½" x 2"	16.500	3.594	3.000	2.80	25H-250200	129.05
3" x 2"	18.000	4.188	3.000	3.20	25H-300200	149.30
3" x 2½"	18.000	4.188	3.594	3.70	25H-300250	172.00

Bevel Seat Ferrules

3 Short Plain Bevel Seat Weld Ferrules - 14PRF

Tube OD	Dimensions		304 Stainless Steel	
	A	B	Part #	Price/E
1"	.718	.870	14PRF-G100	\$12.00
1½"	.718	1.370	14PRF-G150	14.60
2"	.750	1.870	14PRF-G200	19.15
2½"	.875	2.370	14PRF-G250	26.55
3"	.906	2.870	14PRF-G300	34.35
4"	1.031	3.834	14PRF-G400	55.70

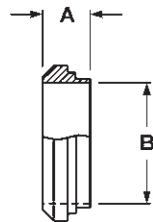

3 Long Plain Bevel Seat Weld Ferrules - 14A

Tube OD	Dimensions		304 Stainless Steel	
	A	B	Part #	Price/E
1"	1.375	.870	14A-G100	\$17.20
1½"	1.500	1.370	14A-G150	21.65
2"	1.500	1.870	14A-G200	32.90
2½"	1.750	2.370	14A-G250	40.70
3"	1.750	2.870	14A-G300	53.65
4"	1.750	3.834	14A-G400	79.25

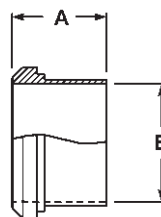

3* Recessless Plain Bevel Seat Ferrules - 14R

- * Meets 3-A Standard Number 63-03 when used to modify or repair existing on-site farm milk handling systems.
- for expanding only

Tube OD	Dimensions		304 Stainless Steel	
	A	B	Part #	Price/E
1½"	1.125	1.500	14R-G150	\$17.60
2"	1.312	2.000	14R-G200	23.05
2½"	1.375	2.500	14R-G250	29.60
3"	1.437	3.000	14R-G300	37.60
4"	1.500	4.000	14R-G400	60.30

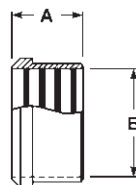

Bevel Seat Ferrules

3 Short Threaded Bevel Seat Weld Ferrules - 15TRF

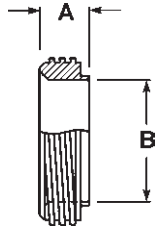

Tube OD	Dimensions		304 Stainless Steel	
	A	B	Part #	Price/E
1"	.718	.870	15TRF-G100	\$14.05
1½"	.718	1.370	15TRF-G150	16.85
2"	.750	1.870	15TRF-G200	22.35
2½"	.875	2.370	15TRF-G250	29.50
3"	.906	2.870	15TRF-G300	38.05
4"	1.031	3.834	15TRF-G400	63.85

3 Long Threaded Bevel Seat Weld Ferrules - 15A

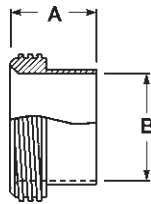

Tube OD	Dimensions		304 Stainless Steel	
	A	B	Part #	Price/E
1"	1.375	0.870	15A-G100	\$23.70
1½"	1.500	1.370	15A-G150	33.15
2"	1.500	1.870	15A-G200	41.20
2½"	1.750	2.370	15A-G250	55.10
3"	1.750	2.870	15A-G300	72.50
4"	1.750	3.834	15A-G400	107.35

3* Recessless Threaded Bevel Seat Ferrules - 15R

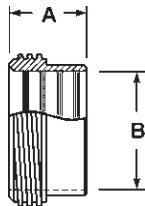

- * Meets 3-A Standard Number 63-03 when used to modify or repair existing on-site farm milk handling systems.
- For expanding only

Tube OD	Dimensions		304 Stainless Steel	
	A	B	Part #	Price/E
1½"	1.125	1.500	15R-G150	\$25.90
2"	1.375	2.000	15R-G200	32.35
2½"	1.500	2.500	15R-G250	44.15
3"	1.675	3.000	15R-G300	52.15
4"	1.675	4.000	15R-G400	82.80

Bevel Seat End Caps

3 Plain Bevel Seat Solid End Caps - 16A



Tube OD	Dimension	304 Stainless Steel	
	A	Part #	Price/E
1"	1.312	16A-G100	\$9.55
1½"	1.843	16A-G150	16.85
2"	2.375	16A-G200	25.30
2½"	2.906	16A-G250	33.80
3"	3.437	16A-G300	49.55
4"	4.500	16A-G400	89.30

Bevel Seat Adapters

Plain Bevel Seat x Male NPT Adapters with Hex Nut - 14-19

Tube OD	Dimension A	304 Stainless Steel	
		Part #	Price/E
1½"	3.250	14-19-G150	\$380.40
2"	3.312	14-19-G200	463.45
3"	4.250	14-19-G300	557.80

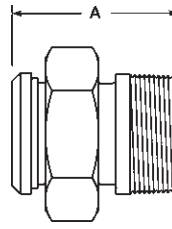

• hex nut is CF8 (304 stainless steel)

Bevel Seat Elbows

Threaded Bevel Seat x Plain Bevel Seat with Hex Nut 90° Elbows - B2F

Tube OD	Dimension A	304 Stainless Steel	
		Part #	Price/E
1½"	2.968	B2F-G150	\$246.25
2"	3.750	B2F-G200	255.95
2½"	4.625	B2F-G250	286.65
3"	5.406	B2F-G300	344.55

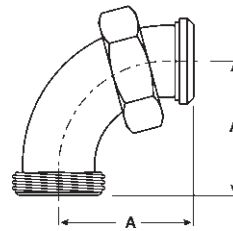

• hex nut is CF8 (304 stainless steel)

Plain Bevel Seat x Plain Bevel Seat with Hex Nut 90° Elbows - B2E

Tube OD	Dimension A	304 Stainless Steel	
		Part #	Price/E
1½"	2.968	B2E-G150	\$243.60
2"	3.750	B2E-G200	305.20
2½"	4.625	B2E-G250	321.05
3"	5.406	B2E-G300	449.15

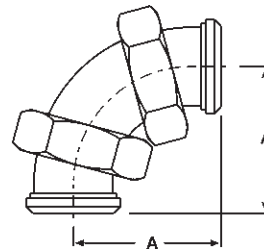

• hex nut is CF8 (304 stainless steel)

Sanitary Fittings

Bevel Seat Reducers

Plain Bevel Seat x Threaded Bevel Seat Concentric Reducers - B3115F

Tube OD	Dimension A	304 Stainless Steel	
		Part #	Price/E
2" x 1½"	3.468	B3115F-G200150	\$163.80
2½" x 2"	3.625	B3115F-G250200	183.80
3" x 2"	5.656	B3115F-G300200	227.70
3" x 2½"	3.781	B3115F-G300250	283.40
4" x 3"	5.937	B3115F-G400300	331.45

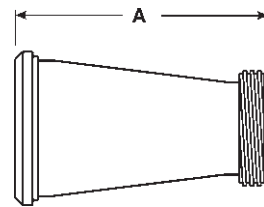

Threaded Bevel Seat x Plain Bevel Seat with Hex Nut Concentric Reducers - B31TP

Tube OD	Dimension A	304 Stainless Steel	
		Part #	Price/E
2" x 1½"	3.468	B31TP-G200150	\$193.05
2½" x 2"	3.625	B31TP-G250200	219.10
3" x 2"	5.656	B31TP-G300200	288.35
3" x 2½"	3.781	B31TP-G300250	325.95
4" x 3"	5.937	B31TP-G400300	395.35

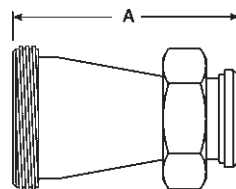

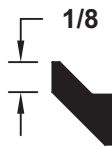
Bevel Seat Gaskets**Buna-N Bevel Seat Gaskets - Black**

- color code: red dot
- meets 21CFR 177.2600

Size	Part #	Price/E
1"	40BS-O100	\$1.65
1½"	40BS-O150	1.40
2"	40BS-O200	1.50
2½"	40BS-O250	2.70
3"	40BS-O300	3.15
4"	40BS-O400	5.60

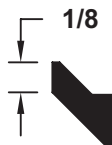
PTFE (Teflon®) Bevel Seat Gaskets - White

- color code: no dot
- meets 21CFR 177.1550
- passed USP Class VI Cytotoxicity testing

Size	Part #	Price/E
1"	40BS-S100	\$2.40
1½"	40BS-S150	2.10
2"	40BS-S200	2.35
2½"	40BS-S250	3.25
3"	40BS-S300	4.40
4"	40BS-S400	6.85

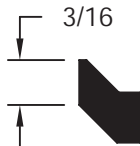
Heavy PTFE (Teflon®) Bevel Seat Gaskets

- color code: no dot
- meets 21CFR 177.1550
- passed USP Class VI Cytotoxicity testing

Size	Part #	Price/E
1"	40BS-H100	\$3.75
1½"	40BS-H150	3.95
2"	40BS-H200	4.40
2½"	40BS-H250	5.90
3"	40BS-H300	8.10
4"	40BS-H400	13.40

I-Line Clamps Heavy Duty Clamps - 13ILH

- wing nut tightened to 25 in. lbs. torque
- CF-8 material

Tube OD	Dimension A	304 Stainless Steel	
		Part #	Price/E
1" - 1½"	2.122	13ILH100-150	\$30.85
2"	2.654	13ILH200	40.85
2½"	3.185	13ILH250	56.05
3"	3.717	13ILH300	68.05
4"	4.820	13ILH400	84.05
6"	7.689	13ILH600	159.00
8"	9.689	13ILH800	213.05



Bolted Clamps - 13ILB

- nut must be tightened to 20 ft. lbs.
- CF-8 material

Tube OD	Dimension A	304 Stainless Steel	
		Part #	Price/E
1" - 1½"	2.122	13ILB100-150	\$32.20
2"	2.654	13ILB200	56.10
2½"	3.185	13ILB250	76.80
3"	3.717	13ILB300	106.20
4"	4.820	13ILB400	128.30

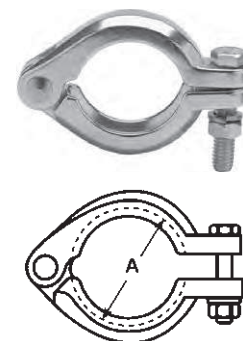

Tube OD	Dimension A	304 Stainless Steel	
		Part #	Price/E
6"	7.689	13ILB600	\$190.90
8"	9.689	13ILB800	436.60

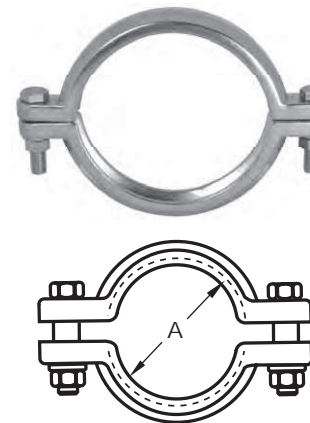

Sanitary Fittings

Q-Line Clamps

Heavy Duty Clamps - 13QLH

- wing nut tightened to 25 in. lbs. torque
- CF-8 material

Tube OD	Dimension A	304 Stainless Steel	
		Part #	Price/E
1" - 1½"	2.122	13QLH100-150	\$30.85
2"	2.654	13QLH200	40.85
2½"	3.185	13QLH250	56.00
3"	3.717	13QLH300	68.05
4"	4.820	13QLH400	84.05

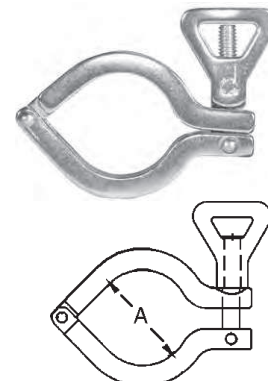

I-Line Ferrules

3 Male I-Line Short Weld Ferrules - 14WI

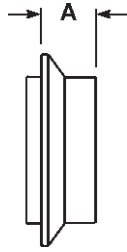

Tube OD	Dim A	304 Stainless Steel		316L Stainless Steel	
		Part #	Price/E	Part #	Price/E
1"	.600	14WI-G100	\$14.55	14WI-R100	\$22.55
1½"	.765	14WI-G150	16.50	14WI-R150	23.40
2"	.790	14WI-G200	25.25	14WI-R200	33.85
2½"	.848	14WI-G250	35.25	14WI-R250	47.75
3"	.906	14WI-G300	46.50	14WI-R300	73.60
4"	1.031	14WI-G400	75.00	14WI-R400	107.00
6"	.940	---	---	14WI-R600	353.45
8"	.940	---	---	14WI-R800	562.50

3 Male I-line Long Weld Ferrules - 14WLI

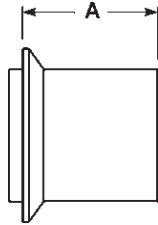

Tube OD	Dim A	304 Stainless Steel		316L Stainless Steel	
		Part #	Price/E	Part #	Price/E
1"	1.562	14WLI-G100	\$48.75	14WLI-R100	\$141.35
1½"	1.843	14WLI-G150	48.80	14WLI-R150	136.95
2"	2.062	14WLI-G200	57.50	14WLI-R200	196.45
2½"	2.188	14WLI-G250	85.35	14WLI-R250	239.45
3"	2.375	14WLI-G300	111.00	14WLI-R300	393.95
4"	2.688	14WLI-G400	161.75	14WLI-R400	1154.55
6"	2.688	---	---	14WLI-R600	1847.20

3 Female I-line Short Weld Ferrules - 15WI

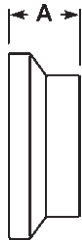

Tube OD	Dim A	304 Stainless Steel		316L Stainless Steel	
		Part #	Price/E	Part #	Price/E
1"	.785	15WI-G100	\$14.55	15WI-R100	\$23.65
1½"	.950	15WI-G150	16.45	15WI-R150	23.90
2"	1.040	15WI-G200	25.25	15WI-R200	34.55
2½"	1.160	15WI-G250	35.25	15WI-R250	50.20
3"	1.220	15WI-G300	48.70	15WI-R300	74.85
4"	1.350	15WI-G400	75.15	15WI-R400	108.65
6"	1.125	---	---	15WI-R600	363.95
8"	1.125	---	---	15WI-R800	532.35

3 Female I-line Long Weld Ferrules - 15WLI

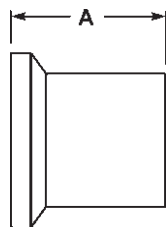

Tube OD	Dim A	304 Stainless Steel		316L Stainless Steel	
		Part #	Price/E	Part #	Price/E
1"	1.750	15WLI-G100	\$45.75	15WLI-R100	\$147.40
1½"	2.031	15WLI-G150	45.75	15WLI-R150	147.40
2"	2.312	15WLI-G200	53.80	15WLI-R200	234.90
2½"	2.500	15WLI-G250	79.95	15WLI-R250	359.85
3"	2.688	15WLI-G300	103.95	15WLI-R300	475.80
4"	3.000	15WLI-G400	151.55	15WLI-R400	685.10
6"	3.000	---	---	15WLI-R600	1664.95

Q-line Ferrules

3 Q-line Weld Ferrules - 14WQ

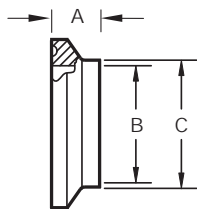

Tube OD	Dimensions			304 Stainless Steel	
	A	B	C	Part #	Price/E
1"	.531	.870	1.000	14WQ-G100	\$51.85
1½"	.563	1.370	1.500	14WQ-G150	38.30
2"	.813	1.870	2.000	14WQ-G200	57.75
2½"	.938	2.370	2.500	14WQ-G250	94.05
3"	.938	2.870	3.000	14WQ-G300	163.20
4"	1.000	3.834	4.000	14WQ-G400	324.95

I-Line End Caps

Male I-line Solid End Caps - 16AI-14I

3
New
for 2012

Tube OD	Dimensions		304 Stainless Steel		316L Stainless Steel	
	A	B	Part #	Price/E	Part #	Price/E
1"	.500	1.985	16AI-14I100	\$16.20	16AI-14I100R	\$0
1½"	.500	1.985	16AI-14I150	16.20	16AI-14I150R	0
2"	.562	2.640	16AI-14I200	24.75	16AI-14I200R	0
2½"	.750	3.307	16AI-14I250	41.45	16AI-14I250R	0
3"	.750	3.870	16AI-14I300	53.90	16AI-14I300R	0
4"	.750	4.870	16AI-14I400	92.15	16AI-14I400R	0
6"	.750	7.495	---	---	16AI-14I600R	0
8"	.880	9.495	---	---	16AI-14I800R	0

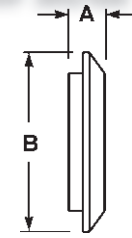

Female I-line Solid End Caps - 16AI-15I

3
New
for 2012

Tube OD	Dimensions		304 Stainless Steel		316L Stainless Steel	
	A	B	Part #	Price/E	Part #	Price/E
1"	.500	1.985	16AI-15I100	\$17.15	16AI-15I100R	\$0
1½"	.500	1.985	16AI-15I150	17.15	16AI-15I150R	0
2"	.562	2.640	16AI-15I200	24.75	16AI-15I200R	0
2½"	.750	3.307	16AI-15I250	41.45	16AI-15I250R	0
3"	.750	3.870	16AI-15I300	53.90	16AI-15I300R	0
4"	.750	4.870	16AI-15I400	92.15	16AI-15I400R	0
6"	.750	7.495	---	---	16AI-15I600R	0
8"	.880	9.495	---	---	16AI-15I800R	0

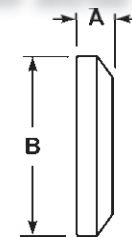

Q-Line Solid End Caps - 16AQ

Tube OD	Dimension A	304 Stainless Steel	
		Part #	Price/E
1"	.313	16AQ-G100	\$39.80
1½"	.313	16AQ-G150	39.80
2"	.438	16AQ-G200	61.15
2½"	.500	16AQ-G250	84.85
3"	.500	16AQ-G300	136.95
4"	.625	16AQ-G400	304.80

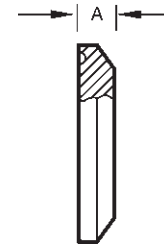

I-Line Gaskets

Buna-N I-Line Gaskets

- color code: red dot
- meets 21CFR 177.2600
- 3/32" thick



Size	Part #	Price/E
1"	40IH100	\$1.80
1½"	40IH150	1.50
2"	40IH200	1.70
2½"	40IH250	2.65
3"	40IH300	3.10
4"	40IH400	4.05
6"	40IH600	41.00
8"	40IH800	46.35

new

PTFE (Teflon®) I-Line Gaskets - White Virgin

- color code: no dot
- meets 21CFR 177.1550
- pharmaceutical class VI approved
- 1/16" thick



Size	Part #	Price/E
1"	40IT100	\$2.05
1½"	40IT150	2.45
2"	40IT200	2.60
2½"	40IT250	3.00
3"	40IT300	3.40
4"	40IT400	4.55
6"	40IT600	68.70
8"	40IT800	80.85

new

EPDM I-Line Gaskets

- color code: three green dots
- meets 21CFR 177.2600
- pharmaceutical class VI approved
- peroxide cured
- 3/32" thick



Size	Part #	Price/E
1"	40IE100	\$2.85
1½"	40IE150	2.85
2"	40IE200	3.15
2½"	40IE250	4.20
3"	40IE300	4.80
4"	40IE400	8.35
6"	40IE600	21.55
8"	40IE800	37.30

new

FKM (Viton®) I-Line Gaskets

- color code: one white dot, one yellow dot
- meets 21CFR 177.2600
- passed USP Class VI Cytotoxicity testing
- peroxide cured
- 1/16" thick



Size	Part #	Price/E
1"	40IV100	\$9.45
1½"	40IV150	12.15
2"	40IV200	14.25
2½"	40IV250	16.90
3"	40IV300	21.20
4"	40IV400	26.65
6"	40IV600	117.70
8"	40IV800	127.65

new

Q-line Gaskets

Buna-N Q-Line Gaskets

- color code: red dot
- meets 21CFR 177.2600



Size	Part #	Price/E
1"	40QH100	\$3.55
1½"	40QH150	3.50
2"	40QH200	4.60
2½"	40QH250	5.75
3"	40QH300	7.45
4"	40QH400	11.45

PTFE (Teflon®) Q-Line Gaskets - White Virgin

- color code: no dot
- meets 21CFR 177.1550
- passed U.S.P. Class VI Cytotoxicity testing



Size	Part #	Price/E
1"	40QT100	\$10.40
1½"	40QT150	10.40
2"	40QT200	13.40
2½"	40QT250	18.10
3"	40QT300	19.20
4"	40QT400	29.30

Pipe Size Clamps

Single Pin Heavy Duty Clamps - 13MHHV

Pipe Size	Dimension A	304 Stainless Steel	
		Part #	Price/E
1"	2.122	13MHHV100	\$15.15
1½"	2.654	13MHHV150	17.15
2"	3.185	13MHHV200	19.65
2½"	3.717	13MHHV250	21.35
3"	4.263	13MHHV300	42.95
4"	5.263	13MHHV400	67.50

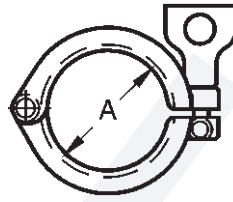

Bolted Clamp - 13MHPV400

Pipe Size	Dimension A	304 Stainless Steel	
		Part #	Price/E
4"	5.187	13MHPV400	\$86.45

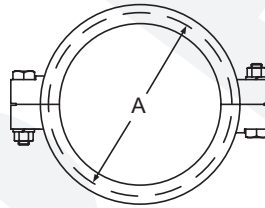

Pipe Size Ferrules

Schedule 5 Short-weld Ferrules - 14WMV

Pipe Size	Dimensions			316L Stainless Steel	
	A	B	C	Part #	Price/E
1"	.500	1.185	1.315	14WMV-R100	\$36.15
1½"	.500	1.770	1.900	14WMV-R150	49.15
2"	.500	2.245	2.375	14WMV-R200	72.45
2½"	.500	2.709	2.875	14WMV-R250	93.45
3"	.500	3.334	3.500	14WMV-R300	117.35
4"	.625	4.334	4.500	14WMV-R400	196.75

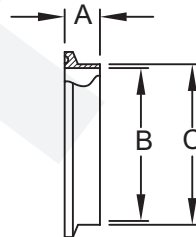

Schedule 10 Short-weld Ferrules - 14WMX

Pipe Size	Dimensions			316L Stainless Steel	
	A	B	C	Part #	Price/E
1"	.500	1.097	1.315	14WMX-R100	\$36.15
1½"	.500	1.682	1.900	14WMX-R150	49.15
2"	.500	2.157	2.375	14WMX-R200	72.45
2½"	.500	2.635	2.875	14WMX-R250	93.45
3"	.500	3.260	3.500	14WMX-R300	117.35
4"	.625	4.260	4.500	14WMX-R400	196.75

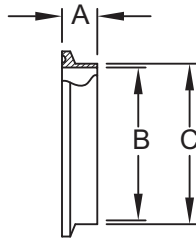

Schedule 5 Long-weld Ferrules - L14AM7V

Pipe Size	Dimensions			316L Stainless Steel	
	A	B	C	Part #	Price/E
1"	1.125	1.185	1.315	L14AM7V-R100	\$71.15
1½"	1.125	1.770	1.900	L14AM7V-R150	90.20
2"	1.125	2.245	2.375	L14AM7V-R200	134.80
2½"	1.125	2.709	2.875	L14AM7V-R250	157.55
3"	1.125	3.334	3.500	L14AM7V-R300	221.90
4"	1.125	4.334	4.500	L14AM7V-R400	330.45

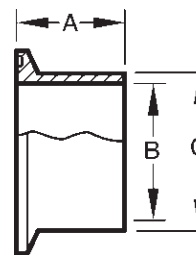

Pipe Size Ferrules

Schedule 10 Long-weld Ferrules - L14AM7X

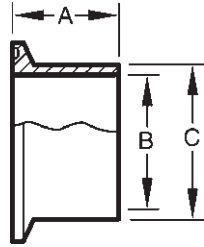

Pipe Size	Dimensions			316L Stainless Steel	
	A	B	C	Part #	Price/E
1"	1.125	1.097	1.315	L14AM7X-R100	\$71.15
1½"	1.125	1.682	1.900	L14AM7X-R150	90.20
2"	1.125	2.157	2.375	L14AM7X-R200	134.80
2½"	1.125	2.635	2.875	L14AM7X-R250	157.55
3"	1.125	3.260	3.500	L14AM7X-R300	221.90
4"	1.125	4.260	4.500	L14AM7X-R400	330.45

Pipe Size End Caps

Solid End Caps - 16AMV

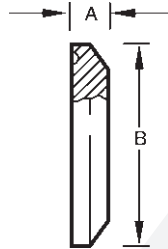

Pipe Size	Dimensions		304 Stainless Steel		316L Stainless Steel	
	A	B	Part #	Price/E	Part #	Price/E
1"	.250	1.984	16AMV-G100	\$8.60	16AMV-R100	\$10.55
1½"	.250	2.516	16AMV-G150	9.45	16AMV-R150	13.60
2"	.250	3.047	16AMV-G200	14.20	16AMV-R200	19.70
2½"	.250	3.579	16AMV-G250	19.45	16AMV-R250	26.70
3"	.312	4.125	16AMV-G300	237.30	16AMV-R300	285.90
4"	.312	5.125	16AMV-G400	321.95	16AMV-R400	438.85

• Specify if you are using a piping system or a tubing system when ordering.

Pipe Size Adapters

Tube Weld x Schedule 5 Weld Adapters - B19WV

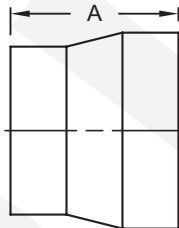
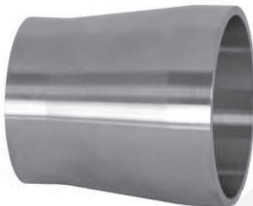

Pipe Size	Dim. A	Tube Wall Thickness	Pipe Wall Thickness	316L Stainless Steel	
				Part #	Price/E
1"	2.000	.065	.065	B19WV-R100	\$99.00
1½"	2.500	.065	.065	B19WV-R150	110.30
2"	2.500	.065	.065	B19WV-R200	129.00
2½"	2.500	.065	.084	B19WV-R250	152.00
3"	2.500	.065	.084	B19WV-R300	173.50
4"	3.000	.084	.084	B19WV-R400	325.35

Tube Weld x Schedule 10 Weld Adapters - B19WX

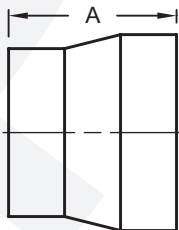
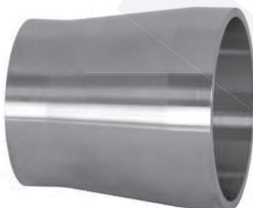

Pipe Size	Dim. A	Tube Wall Thickness	Pipe Wall Thickness	316L Stainless Steel	
				Part #	Price/E
1"	2.000	.065	.109	B19WX-R100	\$99.50
1½"	2.500	.065	.109	B19WX-R150	110.75
2"	2.500	.065	.109	B19WX-R200	129.65
2½"	2.500	.065	.120	B19WX-R250	152.70
3"	2.500	.065	.120	B19WX-R300	174.30
4"	3.000	.084	.120	B19WX-R400	326.80

New for 2012

Clamp x Schedule 10 Weld Adapters - B19MPX

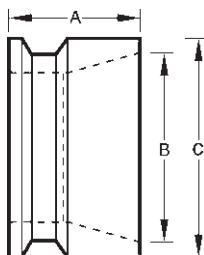
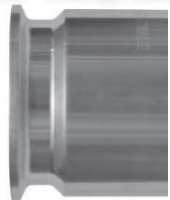

Pipe Size	A	B	C	Pipe Wall Thickness	316L Stainless Steel	
					Part #	Price/E
1"	1.125	1.097	1.315	.109	B19MPX-R100	\$79.00
1½"	1.125	1.682	1.900	.109	B19MPX-R150	157.30
2"	1.125	2.157	2.375	.109	B19MPX-R200	236.85
2½"	1.125	2.635	2.875	.120	B19MPX-R250	259.90
3"	1.125	3.260	3.500	.120	B19MPX-R300	323.30
4"	1.125	4.260	4.500	.120	B19MPX-R400	388.35

Pipe Size Hangers

Hex Pipe Size Hanger with Grommets - B24RV *

Pipe Size	Dimensions		304 Stainless Steel	
	A	B	Part #	Price/E
1"	3.625	2.125	B24RV-G100	\$23.30
1½"	3.625	2.125	B24RV-G150	25.40
2"	4.312	2.625	B24RV-G200	28.00
2½"	4.875	3.125	B24RV-G250	31.80
3"	5.375	3.625	B24RV-G300	37.35
4"	6.562	4.750	B24RV-G400	37.90
6"	9.000	6.625	B24RV-G600	107.30

* for coupler options call Dixon Sanitary

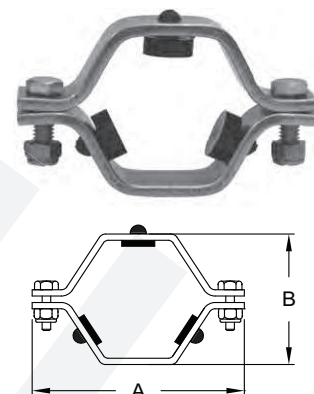

Hex Pipe Size Hanger with Polypropylene Sleeves - B24PV *

Pipe Size	Dimensions		304 Stainless Steel	
	A	B	Part #	Price/E
1"	3.625	2.125	B24PV-G100	\$35.75
1½"	4.312	2.625	B24PV-G150	36.40
2"	4.875	3.125	B24PV-G200	40.15
2½"	4.812	3.125	B24PV-G250	49.60
3"	6.000	4.250	B24PV-G300	49.85
4"	7.500	5.625	B24PV-G400	56.75
6"	9.750	7.375	B24PV-G600	200.70

* for coupler options call Dixon Sanitary

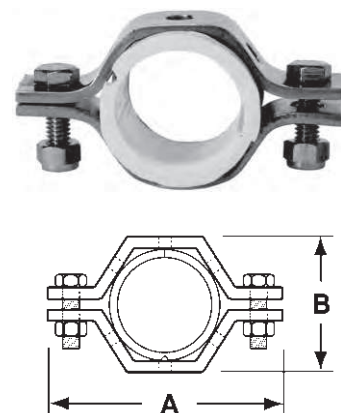

Sanitary Fittings

Polypropylene Pipe Size Sleeves - 13PV

Size	Part #	Price/E
1"	13PV-100	\$19.50
1½"	13PV-150	19.50
2"	13PV-200	19.50
2½"	13PV-250	29.65
3"	13PV-300	31.85
4"	13PV-400	35.75
6"	13PV-600	131.25



Schedule 5 and 10 Pipe Gaskets**Buna-N Pipe Gaskets- 40MPV-U**

- color code: red dot
- meets 21CFR 177.2600

Size	Part #	Price/E
1"	40MPV-U100	\$7.45
1½"	40MPV-U150	7.10
2"	40MPV-U200	7.45
2½"	40MPV-U250	6.80
3"	40MPV-U300	6.95
4"	40MPV-U400	7.10

PTFE (Teflon®) Pipe Gaskets - 40MPV-G

- color code: no dot
- meets 21CFR 177.1550
- passed USP Class VI Cytotoxicity testing
- not recommended for use with bolted clamps

Size	Part #	Price/E
1"	40MPV-G100	\$33.25
1½"	40MPV-G150	25.10
2"	40MPV-G200	31.40
2½"	40MPV-G250	51.75
3"	40MPV-G300	57.50
4"	40MPV-G400	66.75

Weld Elbows

90° Polished Weld Elbow with Tangent - B2S

Tube OD	Dimension A	Nominal Wall	polished ID/OD 304 Stainless Steel		polished ID/OD 316L Stainless Steel	
			Part #	Price/E	Part #	Price/E
¾"	3.000	.065	---	---	B2S-R75P	\$96.60
1"	2.062	.065	B2S-G100P	\$34.00	B2S-R100P	37.95
1½"	2.937	.065	B2S-G150P	36.35	B2S-R150P	42.40
2"	4.062	.065	B2S-G200P	39.50	B2S-R200P	58.55
2½"	5.187	.065	B2S-G250P	56.25	B2S-R250P	88.25
3"	6.312	.065	B2S-G300P	81.85	B2S-R300P	121.60
4"	8.312	.083	B2S-G400P	146.50	B2S-R400P	223.40

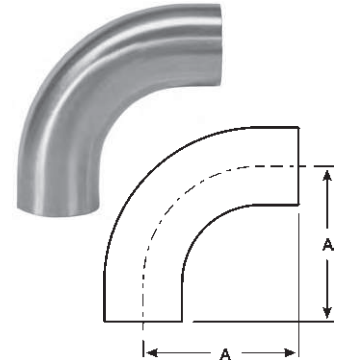

90° Polished Weld Elbow - B2WCL

Tube OD	Dimension A	Nominal Wall	polished ID/OD 304 Stainless Steel		polished ID/OD 316L Stainless Steel	
			Part #	Price/E	Part #	Price/E
½"	1.125	.065	---	---	B2WCL-R50P	\$35.20
¾"	1.125	.065	---	---	B2WCL-R75P	35.20
1"	1.500	.065	B2WCL-G100P	\$18.25	B2WCL-R100P	22.00
1½"	2.250	.065	B2WCL-G150P	23.35	B2WCL-R150P	29.45
2"	3.000	.065	B2WCL-G200P	31.85	B2WCL-R200P	40.55
2½"	3.750	.065	B2WCL-G250P	51.30	B2WCL-R250P	67.20
3"	4.500	.065	B2WCL-G300P	72.95	B2WCL-R300P	93.25
4"	6.000	.083	B2WCL-G400P	139.80	B2WCL-R400P	170.00
6"	9.000	.109	B2WCL-G600P	767.90	B2WCL-R600P	883.40
8"	12.000	.120	B2WCL-G800P	1451.05	B2WCL-R800P	1643.95

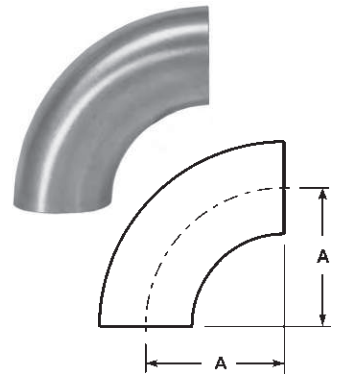

90° Clamp x Polished Weld Elbow - B2CM

Tube OD	Dimensions		Nom. Wall	polished ID/OD 304 Stainless Steel		polished ID/OD 316L Stainless Steel	
	A	B		Part #	Price/E	Part #	Price/E
1"	2.562	2.062	.065	B2CM-G100	\$84.65	B2CM-R100	\$97.80
1½"	3.438	2.937	.065	B2CM-G150	79.50	B2CM-R150	96.55
2"	4.562	4.062	.065	B2CM-G200	94.90	B2CM-R200	110.65
2½"	5.688	5.187	.065	B2CM-G250	124.25	B2CM-R250	154.60
3"	6.812	6.312	.065	B2CM-G300	165.25	B2CM-R300	229.15
4"	8.937	8.312	.083	B2CM-G400	253.25	B2CM-R400	320.20

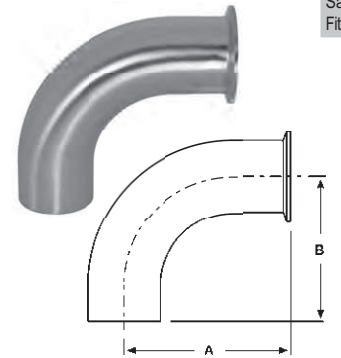

Sanitary Fittings

Plain End Bevel Seat with Hex x 90° Polished Weld Elbow - B2FP

Tube OD	Dimensions		Nominal Wall	polished ID/OD 304 Stainless Steel	
	A	B		Part #	Price/E
1½"	3.656	2.937	.065	B2FP-G150	\$139.60
2"	4.812	4.062	.065	B2FP-G200	158.05
2½"	6.062	5.187	.065	B2FP-G250	234.80
3"	7.218	6.312	.065	B2FP-G300	287.25

• hex nuts are CF8 (304) stainless

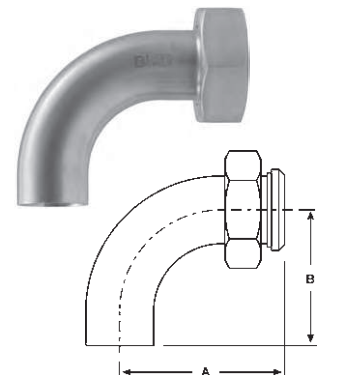

Weld Elbows

3 45° Polished Weld Elbow with Tangent - B2KS

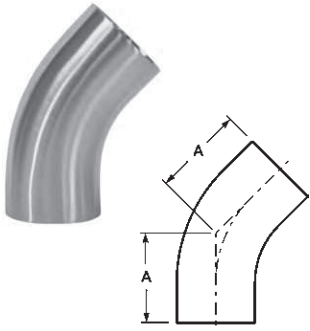

Tube OD	Dimension A	Nominal Wall	polished ID/OD 304 Stainless Steel		polished ID/OD 316L Stainless Steel	
			Part #	Price/E	Part #	Price/E
3/4"	2.250	.065	---	---	B2KS-R75P	\$144.60
1"	1.188	.065	B2KS-G100P	\$27.95	B2KS-R100P	30.35
1 1/2"	1.625	.065	B2KS-G150P	30.35	B2KS-R150P	35.70
2"	2.312	.065	B2KS-G200P	37.50	B2KS-R200P	49.40
2 1/2"	3.000	.065	B2KS-G250P	51.70	B2KS-R250P	68.90
3"	3.688	.065	B2KS-G300P	69.90	B2KS-R300P	99.20
4"	4.812	.083	B2KS-G400P	120.35	B2KS-R400P	161.90

3 45° Polished Weld Elbow - B2WK



Tube OD	Dimensions		Nom. Wall	polished ID/OD 304 Stainless Steel		polished ID/OD 316L Stainless Steel	
	A	R		Part #	Price/E	Part #	Price/E
1"	.625	1.500	.065	B2WK-G100P	\$20.50	B2WK-R100P	\$22.15
1 1/2"	.937	2.250	.065	B2WK-G150P	19.75	B2WK-R150P	22.55
2"	1.250	3.000	.065	B2WK-G200P	26.05	B2WK-R200P	36.05
2 1/2"	1.562	3.750	.065	B2WK-G250P	38.10	B2WK-R250P	52.30
3"	1.875	4.500	.065	B2WK-G300P	64.45	B2WK-R300P	83.30
4"	2.500	6.000	.083	B2WK-G400P	122.40	B2WK-R400P	157.45
6"	3.750	9.000	.109	B2WK-G600P	617.45	B2WK-R600P	758.55
8"	5.000	12.000	.120	---	---	B2WK-R800P	1183.60

3 45° Clamp x Polished Weld Elbow - B2KM

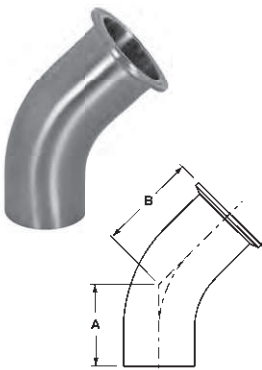

Tube OD	Dimensions		Nom. Wall	polished ID/OD 304 Stainless Steel		polished ID/OD 316L Stainless Steel	
	A	B		Part #	Price/E	Part #	Price/E
1"	1.188	1.688	.065	B2KM-G100	\$96.10	B2KM-R100	\$113.45
1 1/2"	1.625	2.125	.065	B2KM-G150	99.65	B2KM-R150	123.60
2"	2.312	2.812	.065	B2KM-G200	126.50	B2KM-R200	132.85
2 1/2"	3.000	3.500	.065	B2KM-G250	156.50	B2KM-R250	213.85
3"	3.688	4.188	.065	B2KM-G300	211.95	B2KM-R300	258.35
4"	4.812	5.437	.083	B2KM-G400	452.00	B2KM-R400	573.25

Weld Tees

Polished Weld Short Tees - B7WWW 3

Tube OD	Dimensions		Nominal Wall	polished ID/OD 304 Stainless Steel		polished ID/OD 316L Stainless Steel	
	A	B		Part #	Price/E	Part #	Price/E
1"	2.250	1.125	.065	B7WWW-G100P	\$39.40	B7WWW-R100P	\$46.85
1½"	3.312	1.656	.065	B7WWW-G150P	44.45	B7WWW-R150P	49.10
2"	4.124	2.062	.065	B7WWW-G200P	55.90	B7WWW-R200P	62.25
2½"	4.688	2.344	.065	B7WWW-G250P	69.15	B7WWW-R250P	81.15
3"	5.188	2.594	.065	B7WWW-G300P	97.75	B7WWW-R300P	120.20
4"	6.876	3.438	.083	B7WWW-G400P	151.45	B7WWW-R400P	177.60

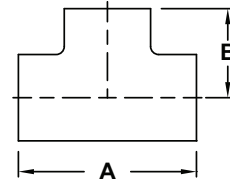
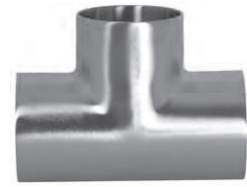

Polished Weld Long Tees - B7W 3

Tube OD	Dimensions		Nominal Wall	polished ID/OD 304 Stainless Steel		polished ID/OD 316L Stainless Steel	
	A	B		Part #	Price/E	Part #	Price/E
¾"	4.000	2.000	.065	---	---	B7W-R75P	\$188.70
1"	3.750	1.875	.065	B7W-G100P	\$44.60	B7W-R100P	53.00
1½"	4.500	2.250	.065	B7W-G150P	44.50	B7W-R150P	58.35
2"	6.000	3.000	.065	B7W-G200P	53.00	B7W-R200P	82.45
2½"	6.000	3.000	.065	B7W-G250P	72.60	B7W-R250P	114.55
3"	6.500	3.250	.065	B7W-G300P	108.55	B7W-R300P	142.25
4"	7.750	3.875	.083	B7W-G400P	191.60	B7W-R400P	264.80

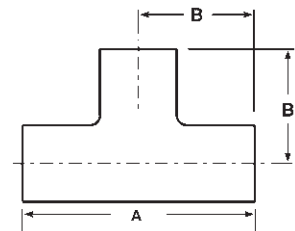

Sanitary Fittings

Polished Weld Reducing Tees - B7RWWW 3

Tube OD	Dimensions				Nom. Wall	polished ID/OD 304 Stainless Steel		polished ID/OD 316L Stainless Steel	
	A	B	C	D		Part #	Price/E	Part #	Price/E
1½" x 1"	3.312	1.375	1.500	1.000	.065	B7RWWW-G150100P	\$68.45	B7RWWW-R150100P	\$84.95
2" x 1"	4.124	1.625	2.000	1.000	.065	B7RWWW-G200100P	94.15	B7RWWW-R200100P	107.65
2" x 1½"	4.124	1.906	2.000	1.500	.065	B7RWWW-G200150P	94.15	B7RWWW-R200150P	107.65
2½" x 1½"	4.688	2.156	2.500	1.500	.065	B7RWWW-G250150P	103.20	B7RWWW-R250150P	110.20
2½" x 2"	4.688	2.312	2.500	2.000	.065	B7RWWW-G250200P	103.20	B7RWWW-R250200P	110.20
3" x 1½"	5.188	2.406	3.000	1.500	.065	B7RWWW-G300150P	144.70	B7RWWW-R300150P	222.85
3" x 2"	5.188	2.562	3.000	2.000	.065	B7RWWW-G300200P	144.70	B7RWWW-R300200P	222.85
4" x 2"	6.876	3.062	4.000	2.000	.083	B7RWWW-G400200P	221.70	B7RWWW-R400200P	333.90
4" x 3"	6.876	3.094	4.000	3.000	.083	B7RWWW-G400300P	221.70	B7RWWW-R400300P	333.90

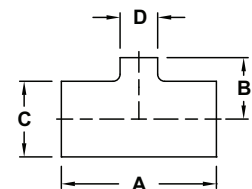

Weld Adapters

Weld Long Hose Adapters - 14WHRL

- suitable for use with band clamps

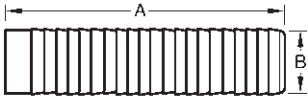
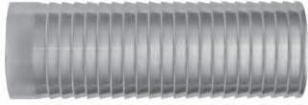

Tube OD	Dimensions		Nominal Wall	316L Stainless Steel	
	A	B		Part #	Price/E
1"	3.000	1.030	.116	14WHRL-R100	\$37.95
1½"	4.500	1.030	.116	14WHRL-R150	64.75
2"	4.500	2.030	.116	14WHRL-R200	82.55
2½"	5.000	2.530	.116	14WHRL-R250	112.90
3"	5.000	3.030	.116	14WHRL-R300	134.65
4"	4.875	4.030	.116	14WHRL-R400	188.80

SAFETY ALERT

Use of PVC tubing requires special techniques to prevent leakage. All assembly work must be done with heated tube. Cold durometer is 90 as opposed to rubber hose at 65 to 70 durometer. Banding buckles must be at 180° from one another.

Weld Reducers

3 Polished Weld Concentric Reducers - B31W

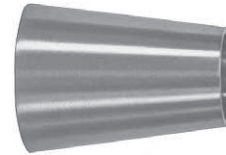
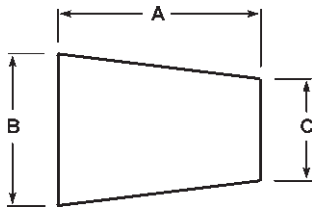

Tube OD	Dimensions			Nom. Wall	polished ID/OD 304 Stainless Steel		polished ID/OD 316L Stainless Steel	
	A	B	C		Part #	Price/E	Part #	Price/E
¾" x ½"	1.000	.750	.500	.065	---	---	B31W-R7550P	\$124.90
1" x ¾"	1.000	1.000	.750	.065	---	---	B31W-R10075P	112.55
1½" x ¾"	3.000	1.500	.750	.065	---	---	B31W-R15075P	196.90
1½" x 1"	2.000	1.500	1.000	.065	B31W-G150100P	\$43.70	B31W-R150100P	61.70
2" x 1"	4.000	2.000	1.000	.065	B31W-G200100P	76.90	B31W-R200100P	121.05
2" x 1½"	2.000	2.000	1.500	.065	B31W-G200150P	44.45	B31W-R200150P	75.20
2½" x 1½"	4.000	2.500	1.500	.065	B31W-G250150P	73.05	B31W-R250150P	134.40
2½" x 2"	2.000	2.500	2.000	.065	B31W-G250200P	51.85	B31W-R250200P	81.90
3" x 1½"	6.000	3.000	1.500	.065	B31W-G300150P	135.45	B31W-R300150P	200.50
3" x 2"	4.000	3.000	2.000	.065	B31W-G300200P	76.25	B31W-R300200P	122.65
3" x 2½"	2.000	3.000	2.500	.065	B31W-G300250P	90.45	B31W-R300250P	149.45
4" x 2"	8.000	4.000	2.000	.083	B31W-G400200P	196.85	B31W-R400200P	290.55
4" x 2½"	6.000	4.000	2.500	.083	B31W-G400250P	210.95	B31W-R400250P	267.90
4" x 3"	4.000	4.000	3.000	.083	B31W-G400300P	113.05	B31W-R400300P	143.90
6" x 3"	5.500	6.000	3.000	.109	B31W-G600300P	503.20	B31W-R600300P	652.25
6" x 4"	5.500	6.000	4.000	.109	B31W-G600400P	438.35	B31W-R600400P	572.70

Weld Reducers

Polished Weld Eccentric Reducers - B32W

Tube OD	Dimensions			Nom. Wall	polished ID/OD 304 Stainless Steel		polished ID/OD 316L Stainless Steel	
	A	B	C		Part #	Price/E	Part #	Price/E
1" x 1/2"	2.000	1.000	.500	.065	---	---	B32W-R10050P	\$251.20
2" x 1"	4.000	2.000	1.000	.065	B32W-G200100P	\$159.90	B32W-R200100P	176.90
2" x 1 1/2"	2.000	2.000	1.500	.065	B32W-G200150P	73.95	B32W-R200150P	100.25
2 1/2" x 2"	2.000	2.500	2.000	.065	B32W-G250200P	77.60	B32W-R250200P	102.65
3" x 2"	4.000	3.000	2.000	.065	B32W-G300200P	125.60	B32W-R300200P	141.90
3" x 2 1/2"	2.000	3.000	2.000	.065	B32W-G300250P	136.30	B32W-R300250P	158.55
4" x 2"	8.000	4.000	2.000	.083	B32W-G400200P	260.75	B32W-R400200P	323.70
4" x 3"	4.000	4.000	3.000	.083	B32W-G400300P	149.90	B32W-R400300P	206.75

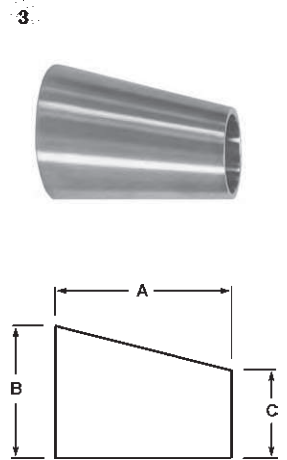

Weld Crosses

Polished Weld Crosses - B9WWWW

Tube OD	Dimensions		Nominal Wall	polished ID/OD 304 Stainless Steel		polished ID/OD 316L Stainless Steel	
	A	B		Part #	Price/E	Part #	Price/E
1 1/2"	3.312	1.656	.065	B9WWWW-G150P	\$241.85	B9WWWW-R150P	\$443.30
2"	4.125	2.062	.065	B9WWWW-G200P	301.60	B9WWWW-R200P	505.20
3"	5.187	2.593	.065	B9WWWW-G300P	435.25	B9WWWW-R300P	819.60
4"	6.875	3.437	.083	B9WWWW-G400P	671.65	B9WWWW-R400P	1047.75

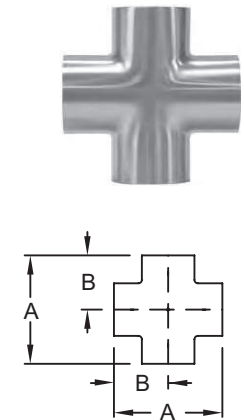

Sanitary Fittings

Miscellaneous Weld Configurations

3 Polished Weld Laterals - B28WA

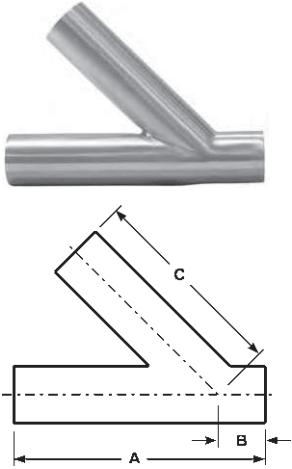

Tube OD	Dimensions			Nominal Wall	polished ID/OD 316L Stainless Steel	
	A	B	C		Part #	Price/E
1"	6.000	1.000	5.000	.065	B28WA-R100P	\$518.95
1½"	7.375	1.188	6.188	.065	B28WA-R150P	518.95
2"	8.750	1.625	7.125	.065	B28WA-R200P	582.95
2½"	10.000	1.500	8.500	.065	B28WA-R250P	703.75
3"	10.750	1.875	8.875	.065	B28WA-R300P	935.50
4"	12.812	2.015	10.750	.083	B28WA-R400P	1734.50

3 Polished Weld True Y - B28W

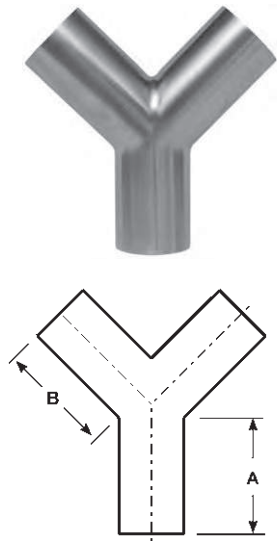

Tube OD	Dimensions		Nominal Wall	polished ID/OD 316L Stainless Steel	
	A	B		Part #	Price/E
1"	2.000	2.438	.065	B28W-R100P	\$470.45
1½"	2.000	2.438	.065	B28W-R150P	517.25
2"	2.625	3.250	.065	B28W-R200P	523.50
2½"	3.370	4.125	.065	B28W-R250P	726.30
3"	4.000	4.875	.065	B28W-R300P	785.30
4"	5.375	5.375	.083	B28W-R400P	1212.65

3 180° Polished Weld Return Bends - B2WUL

- bends are standard 1.5 x tube diameter

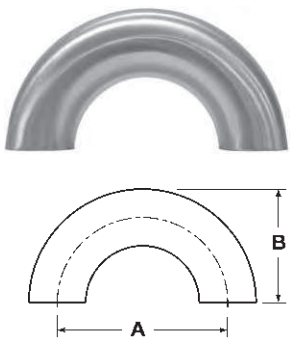

Tube OD	Dimensions		polished ID/OD 316L Stainless Steel	
	A	B	Part #	Price/E
1"	3.000	2.000	B2WUL-R100P	\$216.15
1½"	4.500	3.000	B2WUL-R150P	352.60
2"	6.000	4.000	B2WUL-R200P	454.15
2½"	7.500	5.000	B2WUL-R250P	515.75
3"	9.000	6.000	B2WUL-R300P	749.50
4"	12.000	8.000	B2WUL-R400P	1019.00

Unpolished Elbows

90° Unpolished Weld Elbow with Tangent - B2S

Tube OD	Dimension A	Nominal Wall	unpolished 304 Stainless Steel		unpolished 316L Stainless Steel	
			Part #	Price/E	Part #	Price/E
¾"	3.000	.065	---	---	B2S-R75U	\$75.70
1"	2.062	.065	B2S-G100U	23.30	B2S-R100U	30.65
1½"	2.937	.065	B2S-G150U	26.75	B2S-R150U	35.10
2"	4.062	.065	B2S-G200U	32.25	B2S-R200U	47.30
2½"	5.187	.065	B2S-G250U	46.65	B2S-R250U	74.30
3"	6.312	.065	B2S-G300U	73.20	B2S-R300U	109.40
4"	8.312	.083	B2S-G400U	130.40	B2S-R400U	209.10

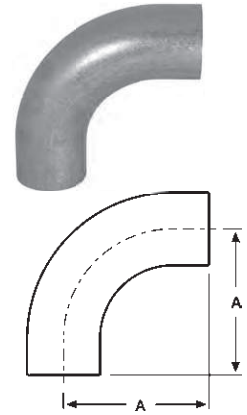

90° Unpolished Weld Elbows - B2WCL

Tube OD	Dimension A	Nominal Wall	unpolished 304 Stainless Steel		unpolished 316L Stainless Steel	
			Part #	Price/E	Part #	Price/E
½"	1.125	.065	---	---	B2WCL-R50U	\$27.50
¾"	1.125	.065	---	---	B2WCL-R75U	29.45
1"	1.500	.065	B2WCL-G100U	\$15.20	B2WCL-R100U	19.90
1½"	2.250	.065	B2WCL-G150U	16.25	B2WCL-R150U	20.45
2"	3.000	.065	B2WCL-G200U	22.55	B2WCL-R200U	29.60
2½"	3.750	.065	B2WCL-G250U	36.50	B2WCL-R250U	47.05
3"	4.500	.065	B2WCL-G300U	52.70	B2WCL-R300U	68.70
4"	6.000	.083	B2WCL-G400U	104.90	B2WCL-R400U	133.55
6"	9.000	.109	B2WCL-G600U	409.35	B2WCL-R600U	599.75
8"	12.000	.120	B2WCL-G800U	698.00	B2WCL-R800U	897.85

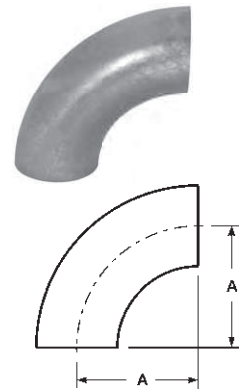

45° Unpolished Weld Elbow with Tangent - B2KS

Tube OD	Dimension A	Nominal Wall	unpolished 304 Stainless Steel		unpolished 316L Stainless Steel	
			Part #	Price/E	Part #	Price/E
¾"	1.125	.065	---	---	B2KS-R75U	\$118.25
1"	1.188	.065	B2KS-G100U	\$21.25	B2KS-R100U	25.90
1½"	1.625	.065	B2KS-G150U	22.65	B2KS-R150U	30.45
2"	2.312	.065	B2KS-G200U	29.75	B2KS-R200U	38.70
2½"	3.000	.065	B2KS-G250U	40.55	B2KS-R250U	60.00
3"	3.688	.065	B2KS-G300U	56.75	B2KS-R300U	80.15
4"	4.812	.083	B2KS-G400U	104.45	B2KS-R400U	140.40

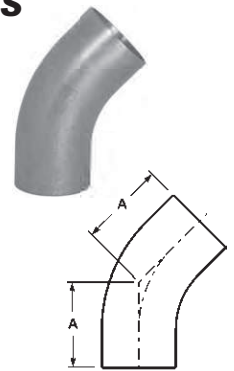

45° Unpolished Weld Elbows - B2WK

Tube OD	Dimensions		Nom. Wall	unpolished 304 Stainless Steel		unpolished 316L Stainless Steel	
	A	R		Part #	Price/E	Part #	Price/E
¾"	.466	1.125	.065	---	---	B2WK-R75U	\$54.60
1"	.625	1.500	.065	B2WK-G100U	\$18.90	B2WK-R100U	20.85
1½"	.937	2.250	.065	B2WK-G150U	15.45	B2WK-R150U	20.15
2"	1.250	3.000	.065	B2WK-G200U	19.90	B2WK-R200U	24.15
2½"	1.562	3.750	.065	B2WK-G250U	28.40	B2WK-R250U	38.30
3"	1.875	4.500	.065	B2WK-G300U	36.45	B2WK-R300U	52.75
4"	2.500	6.000	.083	B2WK-G400U	80.00	B2WK-R400U	102.55
6"	3.750	9.000	.109	B2WK-G600U	337.15	B2WK-R600U	467.30
8"	5.000	12.000	.120	B2WK-G800U	493.70	B2WK-R800U	633.85

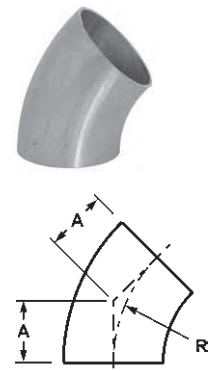

Sanitary Fittings

Unpolished Weld End Caps - **B16W**



Tube OD	Dimension A	unpolished 304 Stainless Steel	
		Part #	Price/E
1"	.375	B16W-G100	\$10.85
1½"	.562	B16W-G150	13.00
2"	.750	B16W-G200	22.05
2½"	1.000	B16W-G250	27.75
3"	1.250	B16W-G300	35.90
4"	1.500	B16W-G400	63.60

Unpolished Adapters

Male NPT x Weld Adapters - **B19WB**



Tube OD	Dimension A	304 Stainless Steel	
		Part #	Price/E
1"	1.750	B19WB-G100	\$18.10
1½"	1.750	B19WB-G150	25.35
2"	1.812	B19WB-G200	36.95
2½"	2.312	B19WB-G250	63.40
3"	2.500	B19WB-G300	85.95
4"	2.562	B19WB-G400	164.60

Female NPT x Weld Adapters - **B22WB**



Tube OD	Dimension A	304 Stainless Steel	
		Part #	Price/E
1"	1.750	B22WB-G100	\$140.55
1½"	1.750	B22WB-G150	164.45
2"	1.812	B22WB-G200	211.65
2½"	2.312	B22WB-G250	329.35
3"	2.500	B22WB-G300	391.95
4"	2.562	B22WB-G400	494.00

Unpolished Tees

Unpolished Weld Short Tees - B7WWW

Tube OD	Dimensions		Nom. Wall	unpolished 304 Stainless Steel		unpolished 316L Stainless Steel	
	A	B		Part #	Price/E	Part #	Price/E
1"	2.250	1.125	.065	B7WWW-G100U	\$22.10	B7WWW-R100U	\$32.85
1½"	3.312	1.656	.065	B7WWW-G150U	23.65	B7WWW-R150U	43.25
2"	4.124	2.062	.065	B7WWW-G200U	30.10	B7WWW-R200U	53.25
2½"	4.688	2.344	.065	B7WWW-G250U	45.95	B7WWW-R250U	87.50
3"	5.188	2.594	.065	B7WWW-G300U	62.15	B7WWW-R300U	90.15
4"	6.876	3.438	.083	B7WWW-G400U	128.80	B7WWW-R400U	167.30

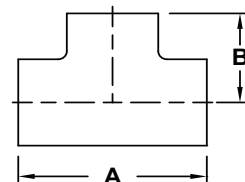

Unpolished Weld Long Tees - B7W

Tube OD	Dimensions		Nom. Wall	unpolished 304 Stainless Steel		unpolished 316L Stainless Steel	
	A	B		Part #	Price/E	Part #	Price/E
¾"	4.000	2.000	.065	---	---	B7W-R75U	\$103.80
1"	3.750	1.875	.065	B7W-G100U	\$25.00	B7W-R100U	31.85
1½"	4.500	2.250	.065	B7W-G150U	27.65	B7W-R150U	40.55
2"	6.000	3.000	.065	B7W-G200U	33.95	B7W-R200U	49.05
2½"	6.000	3.000	.065	B7W-G250U	48.70	B7W-R250U	75.00
3"	6.500	3.250	.065	B7W-G300U	66.30	B7W-R300U	105.70
4"	7.750	3.875	.083	B7W-G400U	109.35	B7W-R400U	226.15

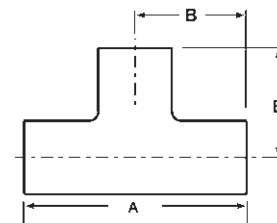

Sanitary Fittings

Unpolished Weld Reducing Tees - B7RWWW

Tube OD	Dimensions				Nom. Wall	unpolished 304 Stainless Steel		unpolished 316L Stainless Steel	
	A	B	C	D		Part #	Price/E	Part #	Price/E
1½" x 1"	3.312	1.375	1.500	1.000	.065	B7RWWW-G150100U	\$35.35	B7RWWW-R150100U	\$65.25
2" x 1"	4.124	1.625	2.000	1.000	.065	B7RWWW-G200100U	44.15	B7RWWW-R200100U	94.90
2" x 1½"	4.124	1.906	2.000	1.500	.065	B7RWWW-G200150U	44.15	B7RWWW-R200150U	94.90
2½" x 1½"	4.688	2.156	2.500	1.500	.065	B7RWWW-G250150U	69.05	B7RWWW-R250150U	78.00
2½" x 2"	4.688	2.312	2.500	2.000	.065	B7RWWW-G250200U	69.05	B7RWWW-R250200U	78.00
3" x 1½"	5.188	2.594	3.000	1.500	.065	B7RWWW-G300150U	100.75	B7RWWW-R300150U	156.45
3" x 2"	5.188	2.594	3.000	2.000	.065	B7RWWW-G300200U	100.75	B7RWWW-R300200U	156.45
4" x 2"	6.876	3.062	4.000	2.000	.083	B7RWWW-G400200U	112.10	B7RWWW-R400200U	162.05
4" x 3"	6.876	3.094	4.000	3.000	.083	B7RWWW-G400300U	112.10	B7RWWW-R400300U	162.05

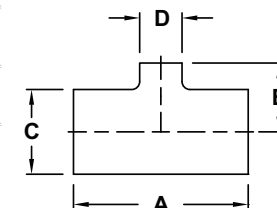
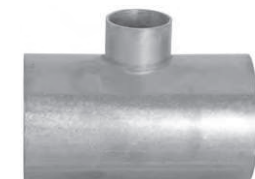

Unpolished Weld Reducers

Unpolished Weld Concentric Reducers - B31W

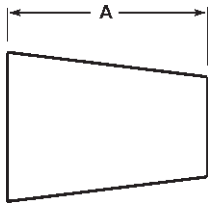

Tube OD	Dim. A	Nom. Wall	unpolished 304 Stainless Steel		unpolished 316L Stainless Steel	
			Part #	Price/E	Part #	Price/E
¾" x ½"	1.000	.065	---	---	B31W-R7550U	\$81.20
1" x ¾"	1.000	.065	---	---	B31W-R10075U	100.55
1½" x ¾"	3.000	.065	---	---	B31W-R15075U	177.15
1½" x 1"	2.000	.065	B31W-G150100U	\$23.65	B31W-R150100U	29.90
2" x 1"	4.000	.065	B31W-G200100U	44.15	B31W-R200100U	67.30
2" x 1½"	2.000	.065	B31W-G200150U	26.65	B31W-R200150U	34.15
2½" x 1½"	4.000	.065	B31W-G250150U	55.15	B31W-R250150U	72.05
2½" x 2"	2.000	.065	B31W-G250200U	31.65	B31W-R250200U	37.95
3" x 1½"	6.000	.065	B31W-G300150U	91.70	B31W-R300150U	144.45
3" x 2"	4.000	.065	B31W-G300200U	53.70	B31W-R300200U	67.45
3" x 2½"	2.000	.065	B31W-G300250U	41.80	B31W-R300250U	52.20
4" x 2"	8.000	.083	B31W-G400200U	132.30	B31W-R400200U	151.15
4" x 2½"	6.000	.083	B31W-G400250U	126.80	B31W-R400250U	154.00
4" x 3"	4.000	.083	B31W-G400300U	54.20	B31W-R400300U	72.95
6" x 4"	5.500	.109	B31W-G600400U	383.70	B31W-R600400U	512.15

Unpolished Weld Eccentric Reducers - B32W

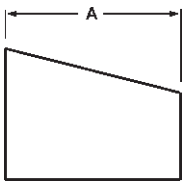

Tube OD	Dim. A	Nom. Wall	unpolished 304 Stainless Steel		unpolished 316L Stainless Steel	
			Part #	Price/E	Part #	Price/E
1" x ½"	2.000	.065	---	---	B32W-R10050U	\$105.60
2" x 1"	4.000	.065	B32W-G200100U	\$65.30	B32W-R200100U	138.20
2" x 1½"	2.000	.065	B32W-G200150U	37.05	B32W-R200150U	39.85
2½" x 2"	2.000	.065	B32W-G250200U	49.05	B32W-R250200U	51.10
3" x 2"	4.000	.065	B32W-G300200U	73.40	B32W-R300200U	102.40
3" x 2½"	2.000	.065	B32W-G300250U	95.75	B32W-R300250U	115.50
4" x 2"	8.000	.083	B32W-G400200U	197.75	B32W-R400200U	270.10
4" x 3"	4.000	.083	B32W-G400300U	84.60	B32W-R400300U	128.85

Unpolished Miscellaneous Configurations

Unpolished Weld Y - B28W

Tube OD	Dimensions		Nominal Wall	unpolished 316L Stainless Steel	
	A	B		Part #	Price/E
1"	2.000	2.438	.065	B28W-R100U	\$307.85
1½"	2.000	2.438	.065	B28W-R150U	394.00
2"	2.625	3.250	.065	B28W-R200U	435.80
2½"	3.370	4.125	.065	B28W-R250U	589.75
3"	4.000	4.875	.065	B28W-R300U	820.35
4"	5.375	5.375	.083	B28W-R400U	906.75

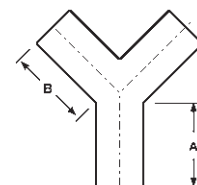

Unpolished Weld Laterals - B28WA

Tube OD	Dimensions			Nominal Wall	unpolished 316L Stainless Steel	
	A	B	C		Part #	Price/E
1"	6.000	1.000	5.000	.065	B28WA-R100U	\$460.55
1½"	7.375	1.188	6.188	.065	B28WA-R150U	483.60
2"	8.750	1.625	7.125	.065	B28WA-R200U	509.50
2½"	10.000	1.500	8.500	.065	B28WA-R250U	571.30
3"	10.750	1.875	8.875	.065	B28WA-R300U	701.75
4"	12.812	2.015	10.750	.083	B28WA-R400U	775.60

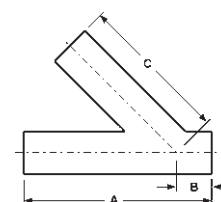

Unpolished 180° Return Bends - B2WUL

• bends are 1.5 x tube diameter

Tube OD	Dimensions		Nominal Wall	unpolished 316L Stainless Steel	
	A	B		Part #	Price/E
1"	3.000	2.000	.065	B2WUL-R100U	\$176.35
1½"	4.500	3.000	.065	B2WUL-R150U	199.35
2"	6.000	4.000	.065	B2WUL-R200U	282.60
2½"	7.500	5.000	.065	B2WUL-R250U	406.00
3"	9.000	6.000	.065	B2WUL-R300U	512.85
4"	12.000	8.000	.083	B2WUL-R400U	568.00

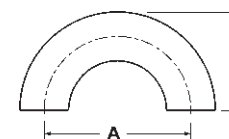

Sanitary Fittings

Unpolished Stub Ends - 14VB

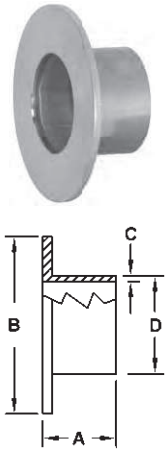

Tube OD	Dimensions				316L Stainless Steel	
	A	B	C	D	Part #	Price/E
1"	1.625	2.000	.065	1.000	14VB-R100	\$65.95
1½"	1.750	2.875	.065	1.500	14VB-R150	74.90
2"	1.500	3.625	.065	2.000	14VB-R200	112.35
2½"	2.000	4.125	.065	2.500	14VB-R250	149.75
3"	2.250	5.000	.065	3.000	14VB-R300	187.20
4"	2.625	6.187	.084	4.000	14VB-R400	299.45

Flanges

Unpolished Slip-On Flanges - B38SL

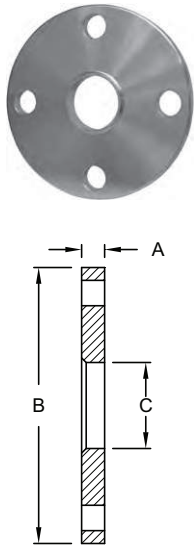

Tube OD	Dimensions			No. & Dia. Bolt Holes	Bolt Circle	304 Stainless Steel		316L Stainless Steel	
	A	B	C			Part #	Price/E	Part #	Price/E
1"	.375	4.250	1.063	4/.625	3.125	B38SL-G100	\$93.70	B38SL-R100	\$136.60
1½"	.375	5.000	1.563	4/.625	3.875	B38SL-G150	122.60	B38SL-R150	167.00
2"	.437	6.000	2.063	4/.750	4.750	B38SL-G200	151.35	B38SL-R200	280.70
3"	.500	7.500	3.063	4/.750	6.000	B38SL-G300	273.95	B38SL-R300	508.30
4"	.562	9.000	4.063	8/.750	7.500	B38SL-G400	396.45	B38SL-R400	720.70
6"	.562	11.000	6.063	8/.875	9.500	B38SL-G600	576.55	B38SL-R600	948.35
8"	.687	13.500	8.063	8/.875	11.750	B38SL-G800	1153.15	B38SL-R800	1669.00

Crowder Supply Co., Inc. • 8495 Roslyn St., Commerce City, CO 80022 • Toll Free: 888-883-5144 • www.CrowderSupply.com

Sanitary Fittings

Tube Hangers

Hex Tube Hanger with Sleeve - B24PS

- supplied with an ABS plastic sleeve to contain the tube
- The ABS plastic sleeve is rated for operating temperatures up to 230°F.

Tube OD	Dimensions		304 Stainless Steel	
	A	B	Part #	Price/E
½"	2.800	1.150	B24PS-G50	\$9.00
¾"	2.800	1.150	B24PS-G75	9.00
1"	3.425	1.450	B24PS-G100	12.70
1½"	4.000	2.125	B24PS-G150	13.90
2"	4.500	2.500	B24PS-G200	16.65
2½"	4.950	3.125	B24PS-G250	19.45
3"	5.500	3.750	B24PS-G300	21.85
4"	6.950	4.750	B24PS-G400	28.80
5"	8.063	5.625	B24PS-G500	82.55
6"	9.250	6.625	B24PS-G600	71.80
8"	11.500	8.625	B24PS-G800	109.70

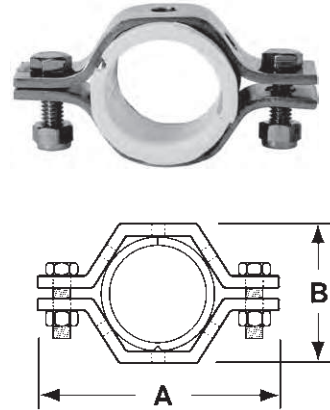

Sleeves - 13PS

- maximum temperature: 230°F
- high temperature sleeves are available

Size	ABS Part #	Price/E	Size	ABS Part #	Price/E
½"	13PS-50	\$6.55	3"	13PS-300	\$8.10
¾"	13PS-75	6.55	4"	13PS-400	10.10
1"	13PS-100	5.25	5"	13PS-500	55.25
1½"	13PS-150	5.25	6"	13PS-600	16.20
2"	13PS-200	5.25	8"	13PS-800	31.60
2½"	13PS-250	7.65			



Sanitary Fittings

Hex Tube Hanger with Grommets - B24RG

- supplied with three nitrile grommets to contain the tube
- replacement grommets are available
- The nitrile grommets have a maximum operating temperature of 230°F.

Tube OD	Dimensions		304 Stainless Steel	
	A	B	Part #	Price/E
½" - ¾"	3.425	1.450	B24RG-G75	\$11.35
1"	3.425	1.450	B24RG-G100	12.50
1½"	4.000	2.125	B24RG-G150	13.45
2"	4.500	2.500	B24RG-G200	16.25
2½"	4.950	3.125	B24RG-G250	18.50
3"	5.500	3.750	B24RG-G300	20.90
4"	6.950	4.750	B24RG-G400	27.25
6"	9.250	6.625	B24RG-G600	45.15
8"	11.500	8.625	B24RG-G800	96.55

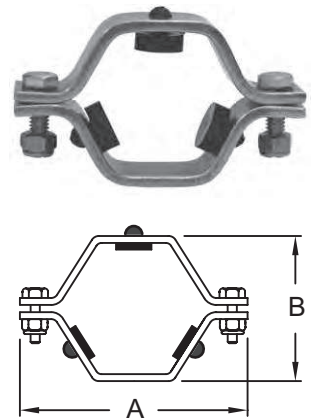

Tube Hangers

Round Tube Hangers - B24RPH

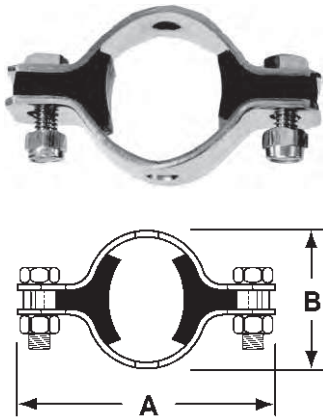

- supplied with shaped inserts that conform to the tube, cutting down on movement and vibration
- The nitrile inserts have a maximum operating temperature of 230°F.

Tube OD	Dimensions		304 Stainless Steel with nitrile insert	
	A	B	Part #	Price/E
1/2"	2.75	1.125	B24RPH-G50	\$12.75
3/4"	2.75	1.125	B24RPH-G75	12.75
1"	3.31	1.500	B24RPH-G100	20.30
1 1/2"	3.81	2.000	B24RPH-G150	21.65
2"	4.25	2.562	B24RPH-G200	25.00
2 1/2"	5.00	3.000	B24RPH-G250	27.80
3"	5.50	3.562	B24RPH-G300	31.25
4"	6.50	4.688	B24RPH-G400	39.45

Nuts and Bolts - 13NHN

- All size hex hangers with grommets and round hangers 1" to 4" use 13NHN-G100-600 fastener sets
- 1/2" and 3/4" round and sleeved hangers use 13NHN-G75 fastener sets
- 2 nuts and bolts supplied to a set

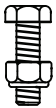

Size	Description	304 Stainless Steel	
		Part #	Price/E
1/2" - 3/4"	1/4-20 x 3/4" bolt with nylock nut	13NHN-G75	\$2.75
1" - 12"	5/16-18 x 1" bolt with nylock nut	13NHN-G100-600	9.90

Wall Flanges - B25

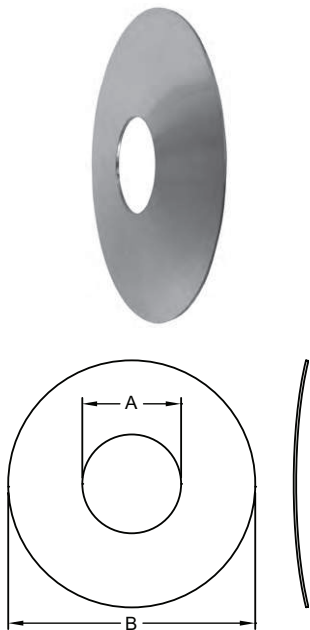

Tube OD	Dimensions		Wall Thickness	304 Stainless Steel	
	A	B		Part #	Price/E
1/2"	.5202	3.0	.065	B25-G050300	\$29.30
1/2"	.5202	5.0	.065	B25-G050500	30.25
3/4"	.7702	3.0	.065	B25-G075300	26.40
3/4"	.7702	5.0	.065	B25-G075500	31.80
1"	1.0202	3.0	.065	B25-G100300	23.95
1"	1.0202	5.0	.065	B25-G100500	27.20
1 1/2"	1.5202	5.0	.065	B25-G150500	27.60
2"	2.0202	5.0	.065	B25-G200500	28.15
2 1/2"	2.5202	5.0	.065	B25-G250500	28.70
3"	3.0202	6.0	.065	B25-G300600	29.10
4"	4.0202	7.0	.065	B25-G400700	35.65
6"	6.0202	10.0	.065	B25-G6001000	152.35
8"	8.0202	12.0	.065	B25-G8001200	200.50
10"	10.0202	14.0	.065	B25-G10001400	232.40
12"	12.0202	16.0	.065	B25-G12001600	254.55

Spray Balls

Rotating Spray Balls

- 304 / 316L stainless steel
- stainless steel ball bearings eliminate rust
- ideal for cleaning all types of tanks and vessels
- cleaning solution lubricates unit
- mirror-like finish (ID/OD)
- spray pattern: 360°
- connections available: clamp and NPT

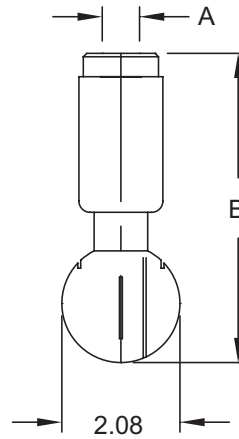

Size	Type	A	B	304 Stainless Steel		316L Stainless Steel	
				Part Number	Price	Part Number	Price
3/4"	NPT	3/4" NPT	5.46	SRH360NPT-G075	\$163.30	---	---
1 1/2"	NPT	1 1/2" NPT	5.46	---	---	SRH360NPT-R150	\$224.60
1 1/2"	Clamp	1.984	5.46	SRH360CMP-G150	201.45	SRH360CMP-R150	238.05

Technical Data

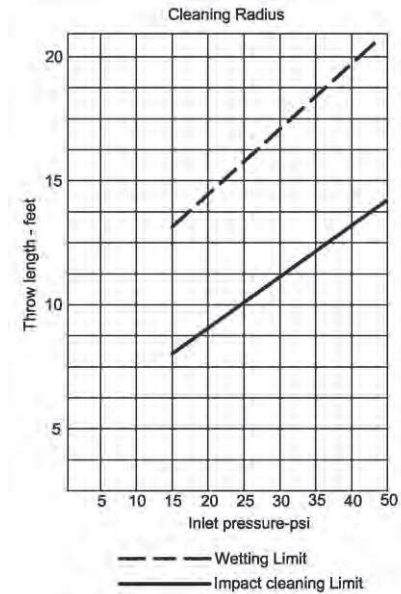
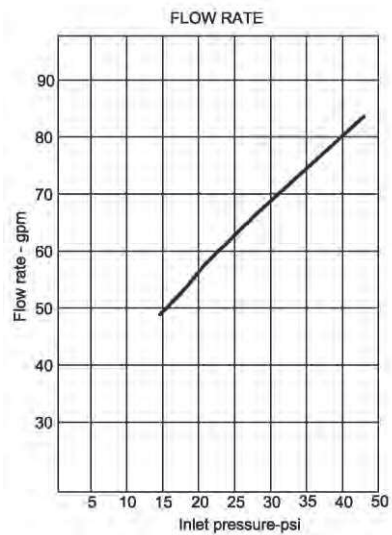

Sanitary Fittings

Spray Balls

Fixed Spray Balls

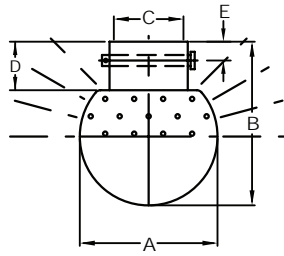

180° Top Pattern

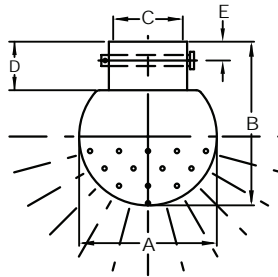

180° Bottom Pattern

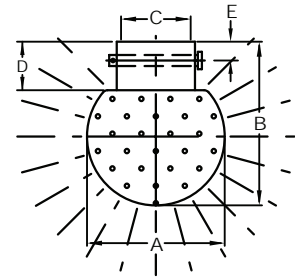

360° Pattern

- 316L stainless steel
- heavy stainless steel construction provides longer life
- various spray patterns available (blanks available as special order)
- stationary - designed to be mounted to a tube or pipe
- typical use is in food and beverage industries for cleaning storage tanks
- 2 mm spray holes

Size	Spray Pattern	Dimensions			Pin Size	D	E	316L Stainless Steel	
		A	B	C				Part #	Price/E
1"	360°	3.04	2.95	1.005	.226	.975	.445	STC-360-R100	\$118.60
1½"	360°	3.54	2.95	1.505	.226	.975	.445	STC-360-R150	175.50
1"	180° bottom	3.54	2.95	1.005	.226	.975	.445	STC-180B-R100	147.10
1½"	180° bottom	3.54	2.95	1.505	.226	.975	.445	STC-180B-R150	212.55
1"	180° top	3.54	2.95	1.005	.226	.975	.445	STC-180T-R100	140.60
1½"	180° top	3.54	2.95	1.505	.226	.975	.445	STC-180T-R150	206.75

1" pin length = 1.47

1½" pin length = 1.95

Repair Kits

Repair kits contain:

- (1) pin
- (1) R clip

Size	Part Number	Price
1"	STC-RK100	\$19.70
1½"	STC-RK150	20.05

Technical Data

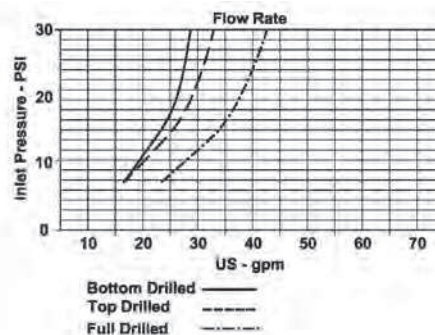
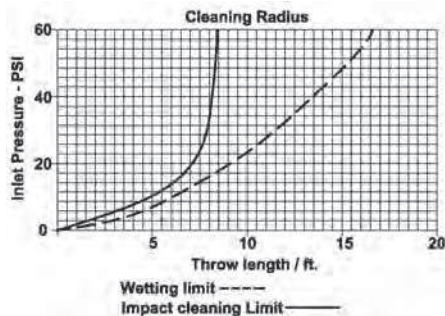

Bradford™ Filters / Strainers



Product Specifications

Size range:

- 1" - 3" clamp

Type:

- Inline
 - > short
 - > long
- Side Entry
 - > long

Material:

- 316L stainless steel

Finish:

- 3A sanitary, ID and OD



What Are Filter / Strainers Used For?

Filter Definition

A filter uses a disposable media to remove finer particulate from the stream. Dixon Sanitary holds Authorization Number 1446 for the 3-A Sanitary Standard for Filters using Single Service Filter Media, Number: 10-4.

Strainer Definition

A strainer is a device used to separate solids from fluids. Here it is used for larger particulate matter from liquid or gas. It uses cleanable media.



Full Flow Filters -
Can be equipped with a variety of filtering media, down to 40 microns, media includes polyester, cotton cheesecloth and nylon mesh.



Full Flow Coarse Strainers -
1/4" or 1/8" perforations.



Full Flow Fine/Medium Strainers -
Can be equipped with a variety of mesh screens for removing finer particles (20 to 1130 mesh).

Sanitary Fittings

Bradford™ Filters / Strainers

In-line Filter / Strainer - BSCCQ

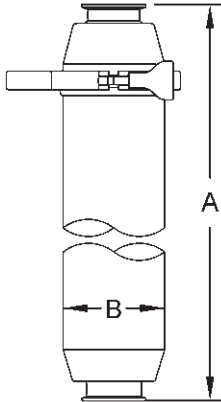

- In-line units ship standard with the following: spring, distributor cap, clamp gasket, 1/4" perforated back-up tube, inlet and outlet bodies and squeeze clamp
- 1/8" perforated back-up tube available, must specify when ordering
- Bevel seat, I-line and weld ends available, call Dixon Sanitary at 800.789.1718 for information

Size	A short	A long	B	Short Part #	Price/E	Long Part #	Price/E
1"	15.75	--	4.00	BSCCQ1-R100	\$1639.75	---	---
1½"	15.75	35.375	4.00	BSCCQ1-R150	1639.75	BSCCQ2-R150	\$2899.70
2"	15.75	35.375	4.00	BSCCQ1-R200	1639.75	BSCCQ2-R200	2899.70
2½"	15.75	--	4.50	BSCCS1-R250	1935.50	---	---
3"	15.75	35.375	4.50	BSCCS1-R300	1935.50	BSCCS2-R300	3543.30

Side-Entry Filter / Strainer - BSCCQ

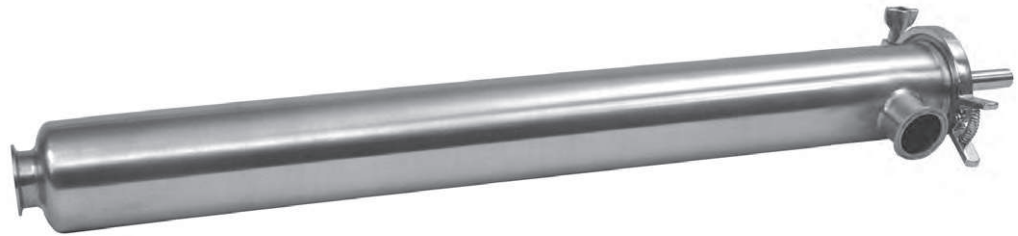
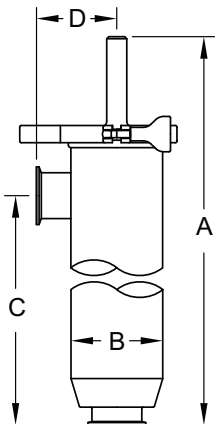

- Side entry units ship standard with the following: spring, end cap with handle, distributor cap, clamp gasket, 1/4" perforated back-up tube, body and squeeze clamp
- 1/8" perforated back-up tube available, must specify when ordering
- Bevel seat, I-line and weld ends available, call Dixon Sanitary at 800.789.1718 for information

Size	A	B	C	D	Part #	Price/E
1½"	41.9	4	35	3½	BSCCQ3-R150	\$3617.05
2"	41.9	4	35	3½	BSCCQ3-R200	3617.05
3"	41.9	4½	35	3¾	BSCCQ3-R300	4454.65

Dimensions are approximate. Engineering dimensions are available upon request.
Specifications are subject to change without notice.

2-Way 3 Piece Encapsulated Ball Valves

- ½" - 2" rated at **1,000 PSI** WOG; 2½" - 4" rated at 800 PSI WOG
- balanced encapsulated construction minimizes cold flow
- live loaded stem packing
- precision stainless steel balls reduce torque and friction losses while extending seat life
- operating parts are stainless steel type CF8M (316) conforming to ASTM A351, (MTRs available upon request)
- integral ISO 5211 mounting pad
- ID polish is Ra 32 minimum
- lockable handle can prevent accidental actuation
- standard internal entry blow out proof stem design
- full port design matches ball and seat ports to tube ID for lower pressure drop and less turbulent flow
- compact design for areas with tight space restrictions
- fully encapsulated construction produces bubble tight seal
- identification tagging available
- virgin PTFE seats

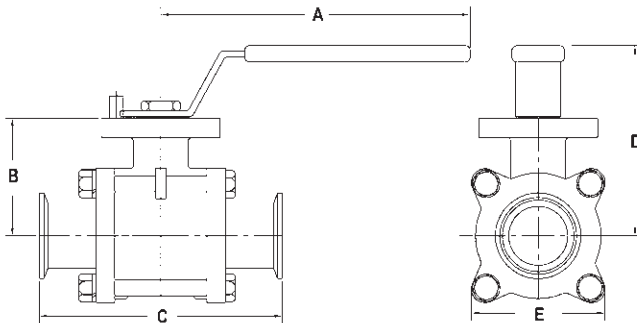

Size	Dimensions					316 Stainless Steel	
	A	B	C	D	E	Part #	Price/E
½"	4.7	1.5	4.3	3	1.9	BV2CV-050CC-A	\$164.90
¾"	4.7	1.8	4.7	3.3	2.2	BV2CV-075CC-A	199.15
1"	5.2	2.1	4.9	3.6	2.4	BV2CV-100CC-A	274.80
1½"	7.2	2.7	5.6	4.4	3.1	BV2CV-150CC-A	463.55
2"	7.2	3.1	6.4	4.8	3.7	BV2CV-200CC-A	670.60
2½"	14.6	3.8	7.8	5.2	4.8	BV2CV-250CC-A	1285.20
3"	14.6	4.2	9	5.7	5.4	BV2CV-300CC-A	1696.50
4"	14.6	5.3	9.5	6.8	8.8	BV2CV-400CC-A	2914.80

Sanitary Fittings

Dixon Sanitary's commitment to excellence and continuous research and development for improving product quality may warrant periodic changes in design and specification. We reserve the right to modify product design without prior notification and without incurring any liability to provide these modifications to products previously purchased.



Literature download for Valve Seat Options
Scan me with your Smart Phone to go to Dixon Sanitary's literature download page.

No reader?
Download a free QR-Code 2D barcode reader.
<http://www.mobile-barcodes.com/qr-code-software/>

For valve seat options, visit www.bradfordittings.com and download the valve seat options literature.

Non-Encapsulated 2-way 3 Piece Stainless Steel Ball Valves**New
for 2012**

- blow-out proof stem
- live-loaded stem packing
- 15% glass reinforced PTFE seats
- CF8M stainless body, ends and ball
- ID polish is R_a 32
- lock-out, tag out
- rated to ½" - 2" **1,000 PSI WOG**
2½" - 4" **800 PSI WOG**

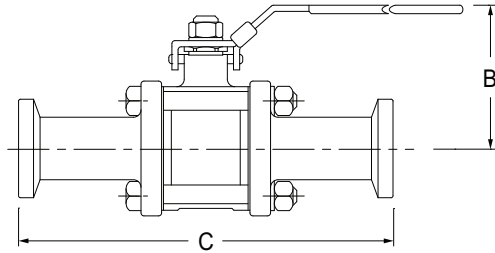
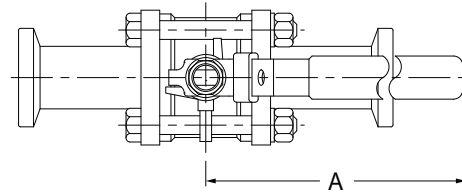

Size	Dimensions			Break Torque (in-lbs.)	Weight (lbs.)	304 Stainless Steel	
	A	B	C			Part #	Price/E
½"	4.1	2.3	4.6	55	1.4	BV2GG-050CC-A	\$151.50
¾"	4.1	2.5	4.7	71	1.8	BV2GG-075CC-A	165.35
1"	5.0	2.8	4.9	101	2.6	BV2GG-100CC-A	243.80
1½"	6.1	3.5	5.6	221	4.6	BV2GG-150CC-A	413.20
2"	7.6	3.9	6.4	345	8.5	BV2GG-200CC-A	622.65
2½"	7.6	4.4	7.8	883	17.8	BV2GG-250CC-A	1097.70
3"	10.9	4.9	9.0	830	28.2	BV2GG-300CC-A	1672.10
4"	13.2	6.6	9.6	1323	41.4	BV2GG-400CC-A	3228.30

Dimensions are approximate. Engineering dimensions are available upon request.
Specifications are subject to change without notice.



Literature download for Valve Seat Options
Scan me with your Smart Phone to go to Dixon Sanitary's literature download page.

No reader?
Download a free QR-Code 2D barcode reader.
<http://www.mobile-barcodes.com/qr-code-software/>

For valve seat options, visit www.bradfordittings.com and download the valve seat options literature.

Butterfly Valves

In addition to a variety of end and seat configurations this butterfly valve also has four handle options.

- A.** The *pull style handle* allows you to set the valve in four different positions simply by pulling and turning.
- B.** The *infinite handle* has incremental marks on the top which can be used when needing a throttling valve.
- C.** The stainless steel *trigger handle* offers twelve positions which make it easy to understand how to actuate the valve.
- D.** The push style handle allows you to set the valve in four different positions simply by pushing down and turning.

- 100% tested / 100% inspected
- 100% pressure hydraulic tested for reliability
- wetted surfaces polished to 3-A standards
- various end configurations available: weld, I-line, Q-line, bevel seat and John Perry
- actuation available: double-acting, air-to-spring, electric
- vacuum rating: 14.2 PSI at 68°F
- temperature range: **15°F to 200°F**
- clamp style is standard

Butterfly Valve with Pull Handle - [A]

Size	316 Stainless Steel with silicone seal		316 Stainless Steel with Viton® seal		316 Stainless Steel with EPDM seal	
	Part #	Price/E	Part #	Price/E	Part #	Price/E
1/2"	B5101S050CC-A	\$325.05	B5101V050CC-A	\$351.60	B5101E050CC-A	\$319.10
3/4"	B5101S075CC-A	325.05	B5101V075CC-A	351.60	B5101E075CC-A	319.10
1"	B5101S100CC-A	305.85	B5101V100CC-A	333.20	B5101E100CC-A	299.90
1 1/2"	B5101S150CC-A	297.50	B5101V150CC-A	340.10	B5101E150CC-A	289.95
2"	B5101S200CC-A	360.30	B5101V200CC-A	421.15	B5101E200CC-A	349.95
2 1/2"	B5101S250CC-A	450.20	B5101V250CC-A	576.45	B5101E250CC-A	427.25
3"	B5101S300CC-A	601.45	B5101V300CC-A	799.45	B5101E300CC-A	583.45
4"	B5101S400CC-A	926.65	B5101V400CC-A	1324.05	B5101E400CC-A	897.65
6"	B5101S600CC-A	2095.70	---	---	B5101E600CC-A	2073.45
8"	---	---	---	---	B5101E800CC-A	6008.15



- valves can be automated, call the factory at 800.789.1718 for details

Size	Dimensions							Break Torque (inch lbs.)	PSI @ 68°F
	A	B	C	D	E	F	G		
1/2"	4.4	2.8	1.4	0.9	3.5	.37	3.1	75	140
3/4"	4.4	2.8	1.4	0.9	3.5	.62	3.1	75	140
1"	4.4	2.8	1.4	0.9	3.5	0.9	3.1	75	140
1 1/2"	4.4	2.8	1.4	0.9	3.5	1.4	3.1	130	140
2"	4.4	3.1	1.4	0.9	3.8	1.9	3.9	165	140
2 1/2"	4.4	3.5	1.4	0.9	3.8	2.4	4.6	210	110
3"	6.2	3.8	1.3	1.2	4.1	2.9	5.2	350	110
4"	6.2	4.5	1.3	1.2	4.8	3.8	6.7	540	85
6"	11.5	5.5	1.3	1.2	5.5	5.8	8.5	1550	60
8"	18.0	6.9	1.6	1.2	4.9	7.8	11.2	1650	60

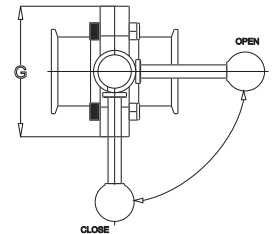
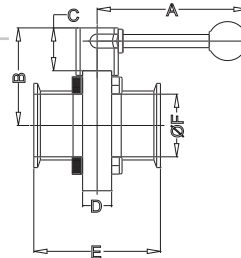

Sanitary Fittings

Butterfly Valves with Infinite Position Handle - [B]

Size	316 Stainless Steel with silicone seal		316 Stainless Steel with Viton® seal		316 Stainless Steel with EPDM seal	
	Part #	Price/E	Part #	Price/E	Part #	Price/E
1/2"	B5101S050CC-B	\$325.05	B5101V050CC-B	\$351.60	B5101E050CC-B	\$319.10
3/4"	B5101S075CC-B	325.05	B5101V075CC-B	351.60	B5101E075CC-B	319.10
1"	B5101S100CC-B	305.85	B5101V100CC-B	333.20	B5101E100CC-B	299.90
1 1/2"	B5101S150CC-B	297.50	B5101V150CC-B	340.10	B5101E150CC-B	289.95
2"	B5101S200CC-B	360.30	B5101V200CC-B	421.15	B5101E200CC-B	349.95
2 1/2"	B5101S250CC-B	450.20	B5101V250CC-B	576.45	B5101E250CC-B	427.25
3"	B5101S300CC-B	601.45	B5101V300CC-B	799.45	B5101E300CC-B	583.45
4"	B5101S400CC-B	926.65	B5101V400CC-B	1324.05	B5101E400CC-B	897.65



- valves can be automated, call the factory at 800.789.1718 for details

Size	Dimensions							Break Torque (inch lbs.)	PSI @ 68°F
	A	B	C	D	E	F	G		
1/2"	4.3	2.6	1.3	0.9	3.5	.37	3.1	75	140
3/4"	4.3	2.6	1.3	0.9	3.5	.62	3.1	75	140
1"	4.3	2.6	1.3	0.9	3.5	0.9	3.1	75	140
1 1/2"	4.3	2.6	1.3	0.9	3.5	1.4	3.1	130	140
2"	4.3	2.9	1.3	0.9	3.8	1.9	3.9	165	140
2 1/2"	4.3	3.3	1.3	0.9	3.8	2.4	4.6	210	110
3"	6.4	3.6	1.3	1.2	4.1	2.9	5.2	350	110
4"	6.4	4.4	1.3	1.2	4.8	3.8	6.7	540	85

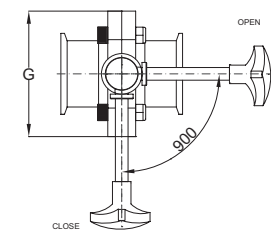
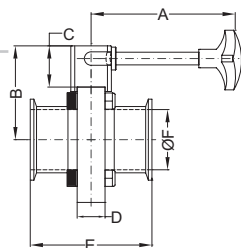

Butterfly Valves

Butterfly Valve with Trigger Handle - [C]



Size	316 Stainless Steel with silicone seal		316 Stainless Steel with Viton® seal		316 Stainless Steel with EPDM seal	
	Part #	Price/E	Part #	Price/E	Part #	Price/E
½"	B5101S050CC-C	\$325.05	B5101V050CC-C	\$351.60	B5101E050CC-C	\$319.10
¾"	B5101S075CC-C	325.05	B5101V075CC-C	351.60	B5101E075CC-C	319.10
1"	B5101S100CC-C	305.85	B5101V100CC-C	333.20	B5101E100CC-C	299.90
1½"	B5101S150CC-C	297.50	B5101V150CC-C	340.10	B5101E150CC-C	329.60
2"	B5101S200CC-C	360.30	B5101V200CC-C	421.15	B5101E200CC-C	349.95
2½"	B5101S250CC-C	450.20	B5101V250CC-C	576.45	B5101E250CC-C	427.25
3"	B5101S300CC-C	601.45	B5101V300CC-C	799.45	B5101E300CC-C	583.45
4"	B5101S400CC-C	926.65	B5101V400CC-C	1324.05	B5101E400CC-C	897.65

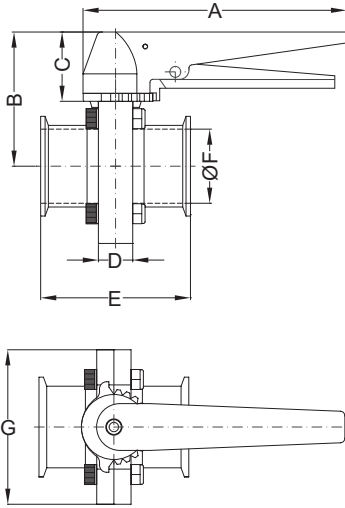

• valves can be automated, call the factory at 800.789.1718 for details
 • lock-out, tag-out ready, .271 diameter hole

Size	Dimensions							BreakTorque (inch lbs.)	PSI @ 68°F
	A	B	C	D	E	F	G		
½"	6.6	3	1.7	0.9	3.5	.37	3.1	75	140
¾"	6.6	3	1.7	0.9	3.5	.62	3.1	75	140
1"	6.6	3	1.7	0.9	3.5	0.9	3.1	75	140
1½"	6.6	3	1.7	0.9	3.5	1.4	3.1	130	140
2"	6.6	3.5	1.7	0.9	3.8	1.9	3.9	165	140
2½"	6.6	3.7	1.7	0.9	3.8	2.4	4.6	210	110
3"	6.6	3.9	1.7	1.2	4.1	2.9	5.2	350	110
4"	6.6	4.8	1.7	1.2	4.8	3.8	6.7	540	85

Butterfly Valve with Push Handle - [D]



Size	316 Stainless Steel with silicone seal		316 Stainless Steel with Viton® seal		316 Stainless Steel with EPDM seal	
	Part #	Price/E	Part #	Price/E	Part #	Price/E
½"	B5101S050CC-D	\$325.05	B5101V050CC-D	\$351.60	B5101E050CC-D	\$319.10
¾"	B5101S075CC-D	325.05	B5101V075CC-D	351.60	B5101E075CC-D	319.10
1"	B5101S100CC-D	305.85	B5101V100CC-D	333.20	B5101E100CC-D	299.90
1½"	B5101S150CC-D	297.50	B5101V150CC-D	340.10	B5101E150CC-D	329.60
2"	B5101S200CC-D	360.30	B5101V200CC-D	421.15	B5101E200CC-D	349.95
2½"	B5101S250CC-D	450.20	B5101V250CC-D	576.45	B5101E250CC-D	427.25
3"	B5101S300CC-D	601.45	B5101V300CC-D	799.45	B5101E300CC-D	583.45
4"	B5101S400CC-D	926.40	B5101V400CC-D	1324.05	B5101E400CC-D	897.65

• valves can be automated, call the factory at 800.789.1718 for details

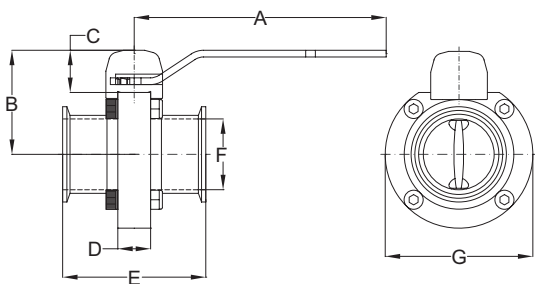

Size	Dimensions							BreakTorque (inch lbs.)	PSI @ 68°F
	A	B	C	D	E	F	G		
½"	6.7	2.4	1.1	0.9	3.5	.37	3.1	75	140
¾"	6.7	2.4	1.1	0.9	3.5	.62	3.1	75	140
1"	6.7	2.4	1.1	0.9	3.5	0.9	3.1	75	140
1½"	6.7	2.4	1.1	0.9	3.5	1.4	3.1	130	140
2"	6.7	2.7	1.1	0.9	3.8	1.9	3.9	165	140
2½"	6.7	3.1	1.1	0.9	3.8	2.4	4.6	210	110
3"	9	3.3	1.1	1.2	4.1	2.9	5.2	350	110
4"	9	4.1	1.1	1.2	4.8	3.8	6.7	540	85

Dixon Sanitary's commitment to excellence and continuous research and development for improving product quality may warrant periodic changes in design and specification. We reserve the right to modify product design without prior notification and without incurring any liability to provide these modifications to products previously purchased.

Butterfly Valves

Repair Kit for Butterfly Valves

Repair Kit contains: • for valves on pages 463-464
 (1) seat
 (2) bushings

Valve Size	Black EPDM		Red Silicone		Brown Viton®	
	Part #	Price/E	Part #	Price/E	Part #	Price/E
1/2" - 1"	B5101-RKE100	\$29.60	B5101-RKS100	\$37.90	B5101-RKV100	\$86.50
1 1/2"	B5101-RKE150	31.95	B5101-RKS150	44.00	B5101-RKV150	119.70
2"	B5101-RKE200	38.75	B5101-RKS200	48.30	B5101-RKV200	156.90
2 1/2"	B5101-RKE250	43.50	B5101-RKS250	53.90	B5101-RKV250	294.00
3"	B5101-RKE300	70.00	B5101-RKS300	85.30	B5101-RKV300	517.35
4"	B5101-RKE400	106.50	B5101-RKS400	131.70	B5101-RKV400	950.45
6"	B5101-RKE600	169.25	B5101-RKS600	324.65	---	---
8"	B5101-RKE800	336.45	---	---	---	---

Clamp Butterfly Valves

- valve is only 1-3/8" wide on all sizes
- valve uses only 3/4" of line space
- the grooved clamp housing connects directly to any sanitary clamp style fitting
- Easy assembly requires a hex key for the handle and wing nuts to secure and seal the housing onto lines.
- actuation available: double acting, spring return and electric

Size	316L Stainless Steel with Silicone seal		316L Stainless Steel with Viton® seal		316L Stainless Steel with EPDM seal	
	Part #	Price/E	Part #	Price/E	Part #	Price/E
1"	B5102S100-A	\$197.90	B5102V100-A	\$244.55	B5102E100-A	\$197.90
1 1/2"	B5102S150-A	197.90	B5102V150-A	242.30	B5102E150-A	197.90
2"	B5102S200-A	240.80	B5102V200-A	295.90	B5102E200-A	240.80
2 1/2"	B5102S250-A	310.90	B5102V250-A	379.50	B5102E250-A	310.90
3"	B5102S300-A	367.80	B5102V300-A	444.30	B5102E300-A	367.80
4"	B5102S400-A	537.60	B5102V400-A	644.95	B5102E400-A	537.60



Sanitary Fittings

- valves can be automated, call the factory at 800.789.1718 for details

Size	Dimensions						Break Torque (inch lbs.)	PSI @ 68°F
	A	B	C	D	E	F		
1"	5.6	2.8	1.3	1.3	3.6	5.6	125	140
1 1/2"	5.6	2.8	1.3	1.3	3.6	5.6	185	140
2"	5.6	3	1.3	1.3	4.1	6.1	200	120
2 1/2"	5.6	3.3	1.3	1.3	4.6	6.6	260	120
3"	5.6	3.6	1.3	1.3	5.3	7.1	350	100
4"	5.6	4.1	1.3	1.3	6.4	8.2	995	70

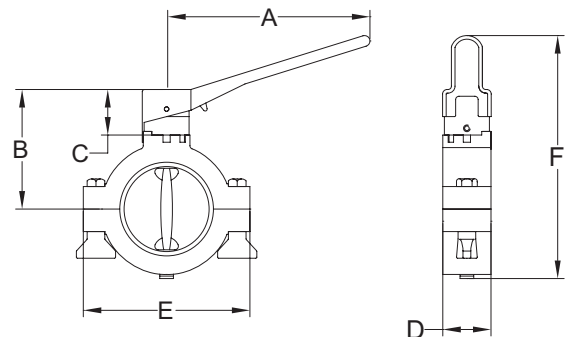

Butterfly Valves

Repair Kit for Clamp Butterfly Valves

Repair Kit contains:

- (1) seat
- (2) bushings
- for valves on page 465

Valve Size	Black EPDM		Red Silicone		Brown Viton®	
	Part #	Price/E	Part #	Price/E	Part #	Price/E
1"	B5102-RKE100	\$23.80	B5102-RKS100	\$31.15	B5102-RKV100	\$107.15
1½"	B5102-RKE150	16.25	B5102-RKS150	24.65	B5102-RKV150	96.15
2"	B5102-RKE200	26.65	B5102-RKS200	33.90	B5102-RKV200	122.15
2½"	B5102-RKE250	34.35	B5102-RKS250	40.40	B5102-RKV250	148.15
3"	B5102-RKE300	78.50	B5102-RKS300	90.65	B5102-RKV300	219.00
4"	B5102-RKE400	105.00	B5102-RKS400	113.65	B5102-RKV400	288.35

Clamp End and Weld End Butterfly Valves

- 100% tested / 100% inspected
- all wetted surfaces are sanitary finished to < 32R_a
- field serviceable (no special tools required)
- seat materials available include: silicone, EPDM, FKM
- PTFE bushings reduce friction and increase cycle life
- minimal line pressure: 0.4 inches Hg vacuum @ 68°F
- operating temperature range: **15°F to 200°F**

New
for 2012

Clamp End Butterfly Valves



Size	CF8M Stainless Steel with Silicone seal		CF8M Stainless Steel with EPDM seal		CF8M Stainless Steel with FKM seal	
	Part #	Price/E	Part #	Price/E	Part #	Price/E
1"	B5104S100CC-D	\$286.10	B5104E100CC-D	\$286.10	B5104V100CC-D	\$365.50
1½"	B5104S150CC-D	312.55	B5104E150CC-D	312.55	B5104V150CC-D	427.70
2"	B5104S200CC-D	337.00	B5104E200CC-D	337.00	B5104V200CC-D	457.65
2½"	B5104S250CC-D	422.65	B5104E250CC-D	422.65	B5104V250CC-D	554.50
3"	B5104S300CC-D	503.05	B5104E300CC-D	503.05	B5104V300CC-D	654.70
4"	B5104S400CC-D	666.85	B5104E400CC-D	666.85	B5104V400CC-D	856.95

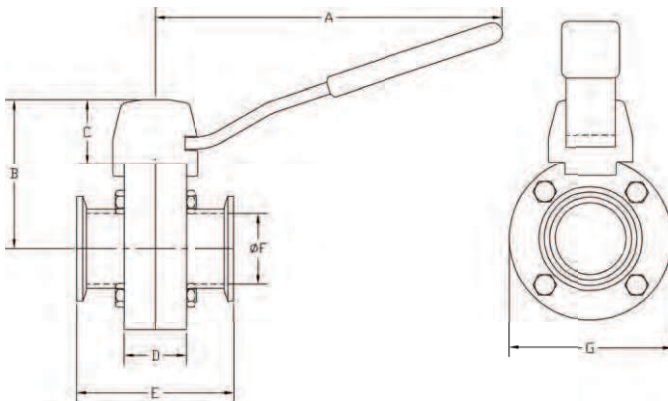

Size	Dimensions						
	A	B	C	D	E	F	G
1"	6.6	2.9	1.2	1.9	3.0	.9	3.1
1½"	6.6	2.9	1.2	1.9	3.0	1.4	3.1
2"	6.6	3.2	1.2	1.9	3.0	1.9	3.7
2½"	6.6	3.4	1.2	1.9	3.0	2.4	4.2
3"	6.6	3.7	1.2	1.9	3.0	2.9	4.8
4"	6.6	4.7	1.7	1.5	3.5	3.8	5.9

Crowder Supply Co., Inc. • 8495 Roslyn St., Commerce City, CO 80022 • Toll Free: 888-883-5144 • www.CrowderSupply.com

Butterfly Valves Weld End Butterfly Valves

**New
for 2012**

Size	CF8M Stainless Steel with Silicone seal		CF8M Stainless Steel with EPDM seal		CF8M Stainless Steel with FKM seal	
	Part #	Price/E	Part #	Price/E	Part #	Price/E
1"	B5104S100BB-D	\$294.30	B5104E100BB-D	\$294.30	B5104V100BB-D	\$375.95
1½"	B5104S150BB-D	321.50	B5104E150BB-D	321.50	B5104V150BB-D	439.95
2"	B5104S200BB-D	346.65	B5104E200BB-D	346.65	B5104V200BB-D	470.70
2½"	B5104S250BB-D	434.70	B5104E250BB-D	434.70	B5104V250BB-D	570.35
3"	B5104S300BB-D	517.40	B5104E300BB-D	517.40	B5104V300BB-D	673.40
4"	B5104S400BB-D	685.85	B5104E400BB-D	685.85	B5104V400BB-D	881.40



Size	Dimensions						
	A	B	C	D	E	F	G
1"	6.6	2.9	1.2	1.9	3.0	.9	3.1
1½"	6.6	2.9	1.2	1.9	3.0	1.4	3.1
2"	6.6	3.2	1.2	1.9	3.0	1.9	3.7
2½"	6.6	3.4	1.2	1.9	3.0	2.4	4.2
3"	6.6	3.7	1.2	1.9	3.0	2.9	4.8
4"	6.6	4.7	1.7	1.5	3.5	3.8	5.9

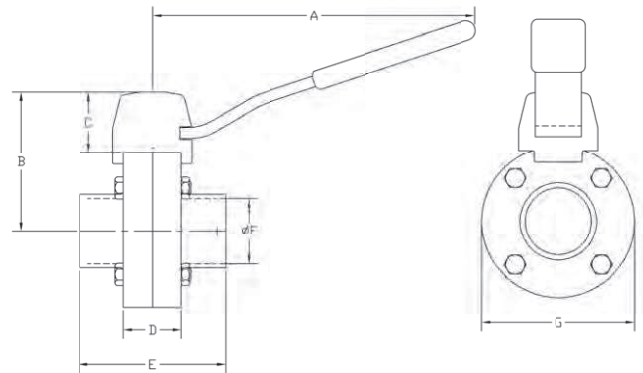

Repair Kit for Clamp End and Weld End Butterfly Valves

Repair Kit contains:

- (1) seat
- (1) bushing
- (1) split bushing

• for valves on page 466-467

**New
for 2012**

Valve Size	Red Silicone		Black EPDM		Black FKM	
	Part #	Price/E	Part #	Price/E	Part #	Price/E
1"	B5104-RKS100	\$30.40	B5104-RKE100	\$30.40	B5104-RKV100	\$85.70
1½"	B5104-RKS150	32.75	B5104-RKE150	32.75	B5104-RKV150	124.40
2"	B5104-RKS200	36.00	B5104-RKE200	36.00	B5104-RKV200	129.05
2½"	B5104-RKS250	47.65	B5104-RKE250	47.65	B5104-RKV250	142.85
3"	B5104-RKS300	57.60	B5104-RKE300	57.60	B5104-RKV300	164.55
4"	B5104-RKS400	76.25	B5104-RKE400	76.25	B5104-RKV400	207.90

Sanitary
Fittings

Spring Check Valves

3
1447

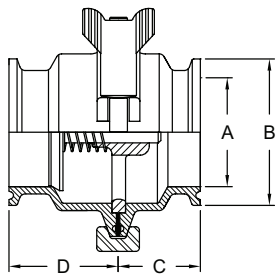

This spring check valve is machined and polished to 3A standards. The clamp assembly design allows quick and easy maintenance and has a special angled plunger design to prevent even low pressure leak-through.

- maximum operating pressure: **145 PSI**
- operating temperature range of **15°F to 200°F**
- full size flow plate with a long bushing helps minimize stem wear

Size	Dimensions				316L Stainless Steel	
	A	B	C	D	Part #	Price/E
½"	0.37	0.99	1.1	1.6	B45MP-R50	\$416.95
¾"	0.62	0.99	1.1	1.6	B45MP-R75	468.40
1"	0.87	1.99	1.7	2.3	B46MP-R100	453.30
1½"	1.37	1.99	1.7	2.3	B46MP-R150	480.75
2"	1.87	2.52	1.7	2.3	B46MP-R200	608.05
2½"	2.37	3.05	1.7	2.3	B46MP-R250	645.60
3"	2.87	3.58	1.7	2.3	B46MP-R300	1,122.30
4" 1	3.83	4.68	2.2	2.7	B46MP-R400	1,437.95

Repair Kit for Spring Check Valves *

Repair Kit contains:

½" - ¾"

- (1) 316L spring
- (1) Viton® stem seat
- (1) Buna body O-ring

Repair Kit contains:

1" - 4"

- (1) 316L spring
- (1) Viton® stem seat
- (1) Buna clamp gasket

Size	Part #	Price/E
½"	B45MP-RK050	\$20.45
¾"	B45MP-RK075	20.45
1"	B46MP-RK100	32.45
1½"	B46MP-RK150	33.95
2"	B46MP-RK200	40.80
2½"	B46MP-RK250	42.10
3"	B46MP-RK300	53.05
4"	B46MP-RK400	56.10

Ball Check Valves

3
1447 58-00

When liquid flows through the valve, the ball is forced into the branch of the valve allowing full fluid flow. When the liquid stops, equalizing the pressure, the ball drops back into the seat, preventing backflow. Should reverse flow occur, the differential pressure will cause the ball to seal firmly against the seat preventing leakage.

- maximum operating pressure: **250 PSI**
- maximum operating temperature: **250°F**
- two piece construction for easier alignment during installation
- various end configurations available: clamp, weld, I-line, Q-line, bevel seat and John Perry
- polished ID and OD to 3A standards
- all metal contact surfaces of 316L stainless steel construction
- air blow check valve can be added (see air blow for sizing)
- PTFE ball

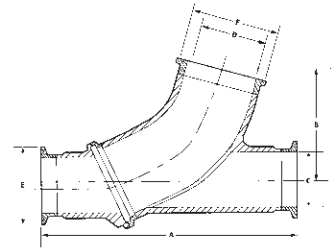

Size	Dimensions						Vertical Seating Pressure (PSI)	316L Stainless Steel	
	A	B	C	D	E	F		Part #	Price/E
1½"	7.5	3.3	1.365	1.875	1.984	2.516	3.6	B45BY-R150	\$837.65
2"	8.5	3.9	1.865	2.335	2.516	3.047	2.6	B45BY-R200	1045.75
2½"	10.0	4.5	2.370	2.870	3.047	3.579	1.6	B45BY-R250	1374.90
3"	11.5	5.3	2.870	3.834	3.579	4.682	1.9	B45BY-R300	2243.45

Kit for Ball Check Valves

Repair Kit contains:

- (1) PTFE ball
- (1) EPDM/CF8M seat
- (1) EPDM cap gasket

Size	Part #	Price/E
1½"	B45BY-RK150	\$181.70
2"	B45BY-RK200	256.60
2½"	B45BY-RK250	536.00
3"	B45BY-RK300	1101.50

Seal Kit contains:

- (1) EPDM/CF8M seat
- (1) EPDM cap gasket

Size	Part #	Price/E
1½"	B45BY-SK150	\$52.25
2"	B45BY-SK200	62.35
2½"	B45BY-SK250	83.20
3"	B45BY-SK300	122.75

All Viton® Seal Kit contains:

- (1) Viton®/CF8M seat
- (1) Viton® cap gasket

Size	Part #	Price/E
1½"	B45BY-SKV150	\$130.20
2"	B45BY-SKV200	162.25
2½"	B45BY-SKV250	210.00
3"	B45BY-SKV300	304.05

Replacement Ball:

- (1) PTFE Ball

Size	Part #	Price/E
1½"	B45BY-TB150	\$142.95
2"	B45BY-TB200	213.10
2½"	B45BY-TB250	491.00
3"	B45BY-TB300	1055.70

Sanitary Fittings

3-1447 58-00

Air Blow Check Valves

The air blow check valve is designed to pressurize lines with air to clean out product or cleaning solutions. It is fail-safe because the simple air-to-open, spring-to-close mechanism prevents backflow. Can be used with a ball check valve. The valves are available with three different end configurations to allow quick assembly and disassembly when replacing filter media, cleaning or inspecting. Conforms to 3A accepted practice 604-05 for supplying air under pressure in contact with milk products and product contact surfaces with optional filter disc.

- EPDM seat and gasket
- conforms to 3A practice 604-05
- filter discs sold separately in packs of 50

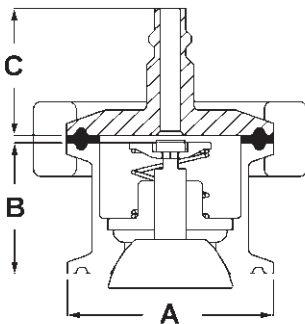

B45AB

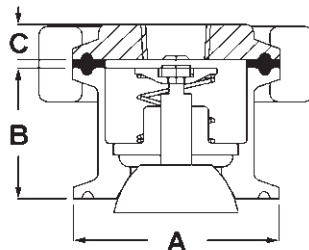

B45BC

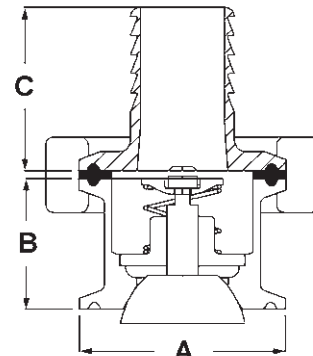

B45CC

Size	Dimensions		Quick Disconnect 316L Stainless Steel		Dim. C	Female NPT 316L Stainless Steel		Dim. C	Hose Barb 316L Stainless Steel		Dim. C
	A	B	Part #	Price/E		Part #	Price/E		Part #	Price/E	
1"-1½"	1.984	1.300	B45AB-R100150	\$363.75	1.26	B45BC-R100150	\$363.75	.60	B45CC-R100150	\$340.10	1.70
2"	2.516	1.300	B45AB-R200	370.65	1.26	B45BC-R200	370.65	.60	B45CC-R200	346.55	1.70
2½"	3.047	1.300	B45AB-R250	477.00	1.26	B45BC-R250	477.00	.60	B45CC-R250	477.00	1.70
3"	3.579	1.300	B45AB-R300	553.55	1.26	B45BC-R300	553.55	.60	B45CC-R300	553.55	1.70
4"	4.682	1.300	B45AB-R400	629.20	1.26	B45BC-R400	588.30	.60	B45CC-R400	588.30	1.70

Repair Kit for Air Blow Check Valves

Repair Kit contains:

- (1) EPDM / 316L stainless perforated disc
- (1) 304 stainless spring retainer
- (1) 304 stainless spring
- (1) nylon stem guide
- (1) EPDM / 316L stem and plug

Part #	Price/E
B45AB-RK	\$152.45

When using air blow check valves with ball check valves, refer to the sizing chart below.

Sizing Chart

Ball Check Valve size	Air Blow Check Valve size
1½"	2"
2"	2½"
2½"	3"
3"	4"

Dixon Sanitary's commitment to excellence and continuous research and development for improving product quality may warrant periodic changes in design and specification. We reserve the right to modify product design without prior notification and without incurring any liability to provide these modifications to products previously purchased.